



PRESTANDEKLARATION

Nr: 18-ONE [SV]

ESSVE
GET IT DONE

Produkttypens unika identifikationskod:

Ankarmassa ESSVE ONE

Ankarmassa ESSVE ONE-ICE

Tillverkare:

ESSVE Produkter AB

BOX 7091

164 07 Kista

Sweden

info@essve.se

Europeisk teknisk bedömning (ETA)	Avsedd användning	Artikelnummer
ETA-18/0617 (2019-12-11)	Bonded anchor consisting of a cartridge with injection mortar ESSVE ONE, or ONE-ICE and a steel element for use in: <ul style="list-style-type: none">cracked concrete strength classes C20/25 to C50/60.uncracked concrete strength classes C20/25 to C50/60.	302334 302336
ETA-18/0642 (2018-10-08)	Bonded anchor consisting of a cartridge with injection mortar ESSVE ONE, ONE-ICE and a steel element for use in: <ul style="list-style-type: none">Masonry bricks defined in the ETAFor other bricks in solid masonry and in hollow or perforated masonry, the characteristic resistance of the anchor may be determined by job site tests according to EOTA Technical Report TR 053 under consideration of the β-factor to ETA Annex C1, Table C1.	302334 302336

Europeisk teknisk bedömning (ETA)	System för bedömning och fortlöpande kontroll av prestanda (AVCP)	Europeiskt bedömningsdokument	Tekniskt bedömningsorgan (TAB)	Anmält organ (NB)
ETA-18/0617 (2019-12-11)	1	EAD 330499-01-0601, (2018-08 draft)	DEUTSCHES INSTITUT FÜR BAUTECHNIK (DIBt)	1343 (FPC)
ETA-18/0642 (2018-10-08)	1	EAD 330076-00-0604, (2014-07)	DEUTSCHES INSTITUT FÜR BAUTECHNIK (DIBt)	1343 (FPC)



PRESTANDEKLARATION

Nr: 18-ONE [SV]

ESSVE
GET IT DONE

Europeisk teknisk bedömning (ETA)	Dimension & Material	Väsentliga egenskaper	Prestanda
ETA-18/0617 (2019-12-11)	Threaded rod M8 to M30 Rebar $\varnothing 8$ to $\varnothing 32$ Internal threaded rod IG-M6 to IG-M20	Characteristic resistance to tension load (static and quasi-static loading)	Annex C1, C2, C4, C6
		Characteristic resistance to shear load (static and quasi-static loading)	Annex C1, C3, C5, C7
		Displacements under short term and long-term loading	Annex C8 – C10
		Durability	Annex B1
	Threaded rod M8 to M30 (except hot-dipped) Rebar $\varnothing 8$ to $\varnothing 32$	Characteristic resistance and displacements for seismic performance category C1	Annex C2, C3, C6, C7
-	-	Characteristic resistance and displacements for seismic performance category C2	NPD
-	-	Content, emission and/or release of dangerous substances	NPD
ETA-18/0642 (2018-10-08)	Threaded rod M8 to M16 IG-M6 to IG-M10	Characteristic values for resistance	Annex C6 – C45
		Reduction β -factors for job-site testing	Annex C1
		Displacements	Annex C5 – C45
		Durability	Annex B1
		Reaction to fire	Class A1
	-	-	Content, emission and/or release of dangerous substances

Prestandan för ovanstående produkt överensstämmer med den angivna prestandan. Denna prestandadeklaration har utfärdats i enlighet med förordning (EU) nr 305/2011 på eget ansvar av den tillverkare som anges ovan.

Undertecknat på tillverkarens vägnar av:

Viktor Bukowski
Product Manager, concrete fasteners

Kista 2020-01-20

[ETA's attached as appendixes]

Approval body for construction products
and types of construction

Bautechnisches Prüfamt

An institution established by the Federal and
Laender Governments



European Technical Assessment

ETA-18/0617
of 11 December 2019

English translation prepared by DIBt - Original version in German language

General Part

Technical Assessment Body issuing the
European Technical Assessment:

Deutsches Institut für Bautechnik

Trade name of the construction product

Injection system ESSVE ONE or
ESSVE ONE-ICE for concrete

Product family
to which the construction product belongs

Bonded fastener for use in concrete

Manufacturer

ESSVE Produkter AB
Esbogatan 14
164 74 KISTA
SCHWEDEN

Manufacturing plant

ESSVE Plant No. 671

This European Technical Assessment
contains

31 pages including 3 annexes which form an integral part
of this assessment

This European Technical Assessment is
issued in accordance with Regulation (EU)
No 305/2011, on the basis of

EAD 330499-01-0601

This version replaces

ETA-18/0617 issued on 15 February 2019

The European Technical Assessment is issued by the Technical Assessment Body in its official language. Translations of this European Technical Assessment in other languages shall fully correspond to the original issued document and shall be identified as such.

Communication of this European Technical Assessment, including transmission by electronic means, shall be in full. However, partial reproduction may only be made with the written consent of the issuing Technical Assessment Body. Any partial reproduction shall be identified as such.

This European Technical Assessment may be withdrawn by the issuing Technical Assessment Body, in particular pursuant to information by the Commission in accordance with Article 25(3) of Regulation (EU) No 305/2011.

Specific Part

1 Technical description of the product

The "Injection System ESSVE ONE, ESSVE ONE-ICE for concrete" is a bonded anchor consisting of a cartridge with injection ESSVE ONE or ESSVE ONE-ICE and a steel element. The steel element consists of a commercial threaded rod with washer and hexagon nut in the range of M8 to M30 or reinforcing bar in the range of \varnothing 8 to \varnothing 32 mm or an internal threaded anchor rod IG-M6 to IG-M20.

The steel element is placed into a drilled hole filled with injection mortar and is anchored via the bond between metal part, injection mortar and concrete.

The product description is given in Annex A.

2 Specification of the intended use in accordance with the applicable European Assessment Document

The performances given in Section 3 are only valid if the anchor is used in compliance with the specifications and conditions given in Annex B.

The verifications and assessment methods on which this European Technical Assessment is based lead to the assumption of a working life of the anchor of at least 50 years. The indications given on the working life cannot be interpreted as a guarantee given by the producer, but are to be regarded only as a means for choosing the right products in relation to the expected economically reasonable working life of the works.

3 Performance of the product and references to the methods used for its assessment

3.1 Mechanical resistance and stability (BWR 1)

Essential characteristic	Performance
Characteristic resistance to tension load (static and quasi-static loading)	See Annex C 1 to C 3, C 5, C 7
Characteristic resistance to shear load (static and quasi-static loading)	See Annex C1, C 4, C 6, C 8
Displacements (static and quasi-static loading)	See Annex C 9 to C 11
Characteristic resistance and displacements for seismic performance categories C1	See Annex C 12 to C 16
Characteristic resistance and displacements for seismic performance categories C2	No performance assessed
Durability	See Annex B 1

3.2 Hygiene, health and the environment (BWR 3)

Essential characteristic	Performance
Content, emission and/or release of dangerous substances	No performance assessed

4 Assessment and verification of constancy of performance (AVCP) system applied, with reference to its legal base

In accordance with the European Assessment Document EAD 330499-01-0601 the applicable European legal act is: [96/582/EC].

The system to be applied is: 1

5 Technical details necessary for the implementation of the AVCP system, as provided for in the applicable European Assessment Document

Technical details necessary for the implementation of the AVCP system are laid down in the control plan deposited at Deutsches Institut für Bautechnik.

Issued in Berlin on 11 December 2019 by Deutsches Institut für Bautechnik

Dr.-Ing. Lars Eckfeldt
p.p. Head of Department

beglaubigt:
Baderschneider

Installation threaded rod M8 up to M30

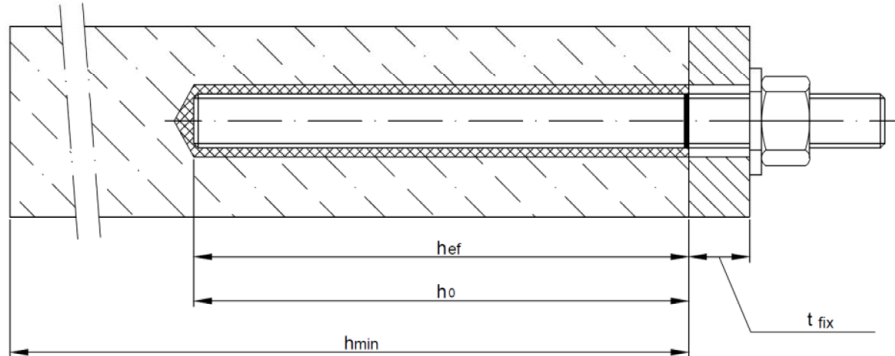

Installation reinforcing bar $\varnothing 8$ up to $\varnothing 32$

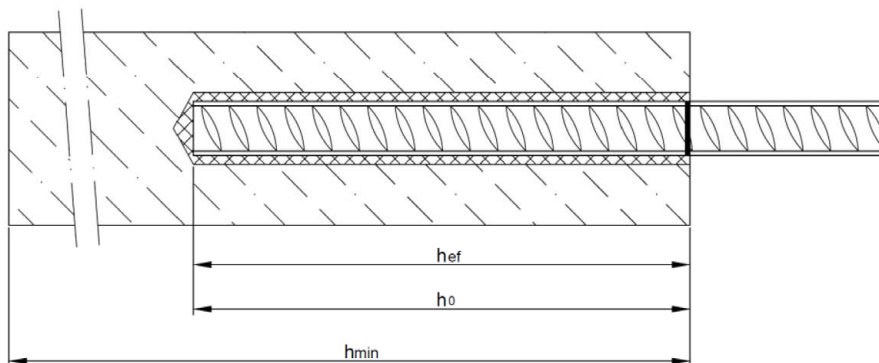

Installation internal threaded anchor rod IG-M6 up to IG-M20

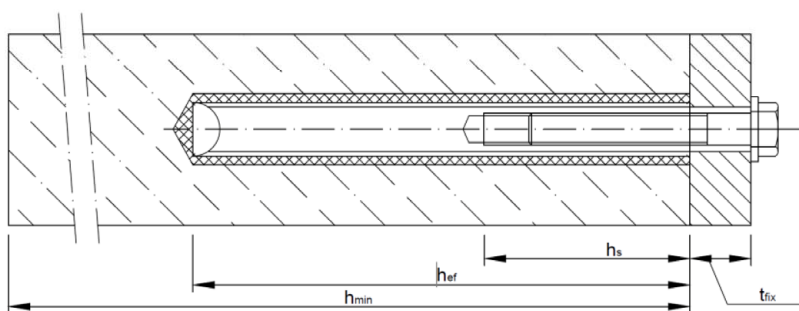

- t_{fix} = thickness of fixture
- h_{ef} = effective anchorage depth
- h_0 = depth of drill hole
- h_{min} = minimum thickness of member

Injection System ESSVE ONE, ESSVE ONE-ICE for concrete

Product description
Installed condition

Annex A 1

Cartridge: ESSVE ONE or ESSVE ONE-ICE

150 ml, 280 ml, 300 ml up to 333 ml and 380 ml up to 420 ml cartridge (Type: coaxial)

Sealing/Screw cap

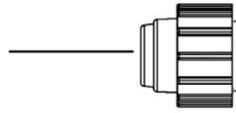

Imprint: ESSVE ONE or ESSVE ONE-ICE, processing notes, charge-code, shelf life, storage temperature, hazard-code, curing- and processing time (depending on the temperature), with as well as without travel scale

235 ml, 345 ml up to 360 ml and 825 ml cartridge (Type: "side-by-side")

Sealing/Screw cap

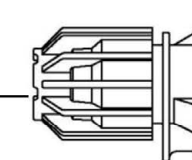

Imprint: ESSVE ONE or ESSVE ONE-ICE, processing notes, charge-code, shelf life, storage temperature, hazard-code, curing- and processing time (depending on the temperature), with as well as without travel scale

165 ml and 300 ml cartridge (Type: "foil tube")

Sealing/Screw cap

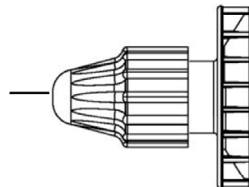

Imprint: ESSVE ONE or ESSVE ONE-ICE, processing notes, charge-code, shelf life, storage temperature, hazard-code, curing- and processing time (depending on the temperature), with as well as without travel scale

Static Mixer

CRW 14W

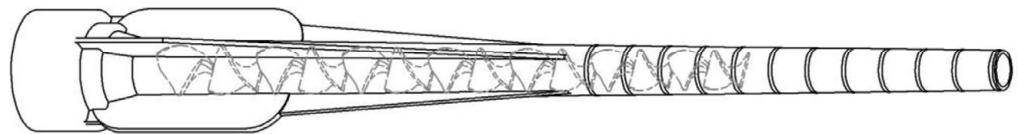

TAH 18W

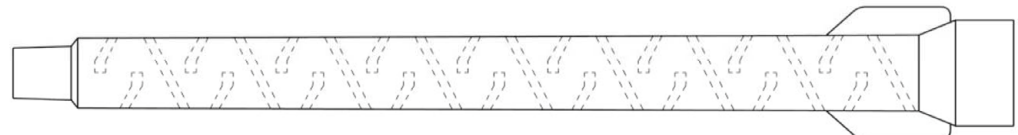

Injection System ESSVE ONE, ESSVE ONE-ICE for concrete

Product description
Injection system

Annex A 2

Threaded rod M8, M10, M12, M16, M20, M24, M27, M30 with washer and hexagon nut

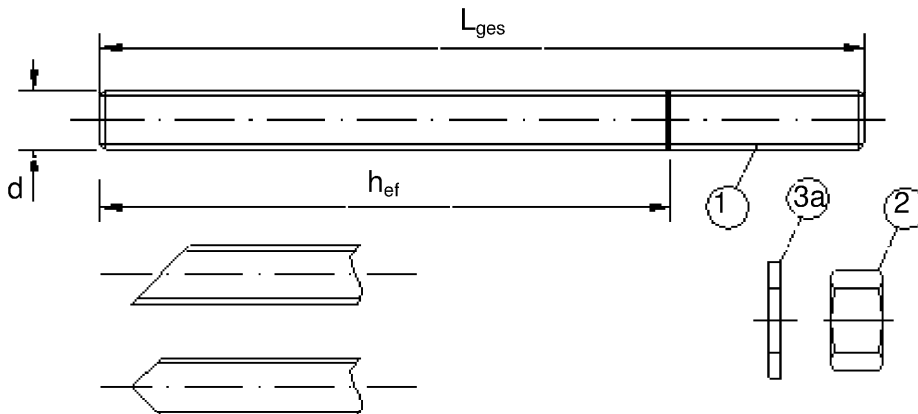



- Commercial standard threaded rod with:
- Materials, dimensions and mechanical properties acc. Table A1
 - Inspection certificate 3.1 acc. to EN 10204:2004
 - Marking of embedment depth

Internal threaded anchor rod IG-M6, IG-M8, IG-M10, IG-M12, IG-M16, IG-M20

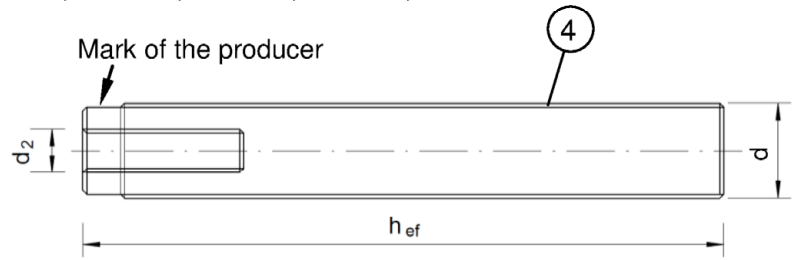
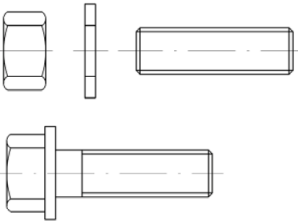
Threaded rod or screw



Marking: e.g.  M8

 Marking Internal thread
 Mark

M8 Thread size (Internal thread)
A4 additional mark for stainless steel
HCR additional mark for high-corrosion resistance steel

Filling washer and mixer reduction nozzle for filling the annular gap between anchor rod and fixture

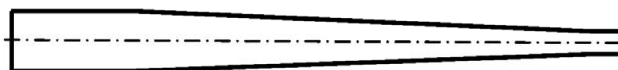
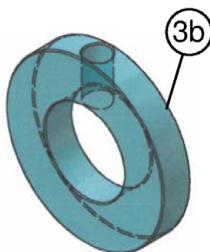

Injection System ESSVE ONE, ESSVE ONE-ICE for concrete

Product description

Threaded rod, internal threaded rod and filling washer

Annex A 3

Table A1: Materials						
Part	Designation	Material				
Steel, zinc plated (Steel acc. to EN 10087:1998 or EN 10263:2001)						
- zinc plated $\geq 5 \mu\text{m}$ acc. to EN ISO 4042:1999 or						
- hot-dip galvanised $\geq 40 \mu\text{m}$ acc. to EN ISO 1461:2009 and EN ISO 10684:2004+AC:2009 or						
- sherardized $\geq 45 \mu\text{m}$ acc. to EN ISO 17668:2016						
1	Threaded rod	Property class	Characteristic tensile strength	Characteristic yield strength	Elongation at fracture	
		acc. to EN ISO 898-1:2013	4.6	$f_{uk} = 400 \text{ N/mm}^2$	$f_{yk} = 240 \text{ N/mm}^2$	$A_5 > 8\%$
			4.8	$f_{uk} = 400 \text{ N/mm}^2$	$f_{yk} = 320 \text{ N/mm}^2$	$A_5 > 8\%$
			5.6	$f_{uk} = 500 \text{ N/mm}^2$	$f_{yk} = 300 \text{ N/mm}^2$	$A_5 > 8\%$
			5.8	$f_{uk} = 500 \text{ N/mm}^2$	$f_{yk} = 400 \text{ N/mm}^2$	$A_5 > 8\%$
8.8	$f_{uk} = 800 \text{ N/mm}^2$	$f_{yk} = 640 \text{ N/mm}^2$	$A_5 \geq 8\%$			
2	Hexagon nut	acc. to EN ISO 898-2:2012	4	for threaded rod class 4.6 or 4.8		
			5	for threaded rod class 5.6 or 5.8		
			8	for threaded rod class 8.8		
3a	Washer	Steel, zinc plated, hot-dip galvanised or sherardized (e.g.: EN ISO 887:2006, EN ISO 7089:2000, EN ISO 7093:2000 or EN ISO 7094:2000)				
3b	Filling washer	Steel, zinc plated, hot-dip galvanised or sherardized				
4	Internal threaded anchor rod	Property class	Characteristic tensile strength	Characteristic yield strength	Elongation at fracture	
		acc. to EN ISO 898-1:2013	5.8	$f_{uk} = 500 \text{ N/mm}^2$	$f_{yk} = 400 \text{ N/mm}^2$	$A_5 > 8\%$
			8.8	$f_{uk} = 800 \text{ N/mm}^2$	$f_{yk} = 640 \text{ N/mm}^2$	$A_5 > 8\%$
Stainless steel A2 (Material 1.4301 / 1.4307 / 1.4311 / 1.4567 or 1.4541, acc. to EN 10088-1:2014)						
Stainless steel A4 (Material 1.4401 / 1.4404 / 1.4571 / 1.4362 or 1.4578, acc. to EN 10088-1:2014)						
High corrosion resistance steel (Material 1.4529 or 1.4565, acc. to EN 10088-1: 2014)						
1	Threaded rod ¹⁾³⁾	Property class	Characteristic tensile strength	Characteristic yield strength	Elongation at fracture	
		acc. to EN ISO 3506-1:2009	50	$f_{uk} = 500 \text{ N/mm}^2$	$f_{yk} = 210 \text{ N/mm}^2$	$A_5 \geq 8\%$
			70	$f_{uk} = 700 \text{ N/mm}^2$	$f_{yk} = 450 \text{ N/mm}^2$	$A_5 \geq 8\%$
80	$f_{uk} = 800 \text{ N/mm}^2$	$f_{yk} = 600 \text{ N/mm}^2$	$A_5 \geq 8\%$			
2	Hexagon nut ¹⁾³⁾	acc. to EN ISO 3506-1:2009	50	for threaded rod class 50		
			70	for threaded rod class 70		
			80	for threaded rod class 80		
3a	Washer	A2: Material 1.4301 / 1.4307 / 1.4311 / 1.4567 or 1.4541, acc. to EN 10088-1:2014 A4: Material 1.4401 / 1.4404 / 1.4571 / 1.4362 or 1.4578, acc. to EN 10088-1:2014 HCR: Material 1.4529 or 1.4565, acc. to EN 10088-1: 2014 (e.g.: EN ISO 887:2006, EN ISO 7089:2000, EN ISO 7093:2000 or EN ISO 7094:2000)				
3b	Filling washer	Stainless steel A4, High corrosion resistance steel				
4	Internal threaded anchor rod ¹⁾²⁾	Property class	Characteristic tensile strength	Characteristic yield strength	Elongation at fracture	
		acc. to EN ISO 3506-1:2009	50	$f_{uk} = 500 \text{ N/mm}^2$	$f_{yk} = 210 \text{ N/mm}^2$	$A_5 > 8\%$
			70	$f_{uk} = 700 \text{ N/mm}^2$	$f_{yk} = 450 \text{ N/mm}^2$	$A_5 > 8\%$
¹⁾ Property class 70 for threaded rods up to M24 and Internal threaded anchor rods up to IG-M16, ²⁾ for IG-M20 only property class 50 ³⁾ Property class 80 only for stainless steel A4						
Injection System ESSVE ONE, ESSVE ONE-ICE for concrete					Annex A 4	
Product description Materials threaded rod and internal threaded rod						

Reinforcing bar $\varnothing 8, \varnothing 10, \varnothing 12, \varnothing 14, \varnothing 16, \varnothing 20, \varnothing 25, \varnothing 28, \varnothing 32$

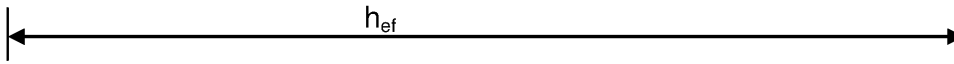
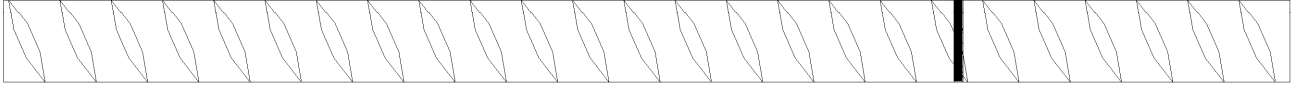

- Minimum value of related rip area $f_{R,min}$ according to EN 1992-1-1:2004+AC:2010
- Rib height of the bar shall be in the range $0,05d \leq h \leq 0,07d$
(d: Nominal diameter of the bar; h: Rip height of the bar)

Table A2: Materials

Part	Designation	Material
Reinforcing bars		
1	Rebar EN 1992-1-1:2004+AC:2010, Annex C	Bars and de-coiled rods class B or C f_{yk} and k according to NDP or NCL of EN 1992-1-1/NA $f_{uk} = f_{tk} = k \cdot f_{yk}$

Injection System ESSVE ONE, ESSVE ONE-ICE for concrete

Product description
Materials reinforcing bar

Annex A 5

Specifications of intended use

Anchorage subject to:

- Static and quasi-static loads: M8 to M30, Rebar Ø8 to Ø32, IG-M6 to IG-M20.
- Seismic action for Performance Category C1: M8 to M30, Rebar Ø8 to Ø32.

Base materials:

- Compacted, reinforced or unreinforced normal weight concrete without fibres according to EN 206:2013 + A1:2016.
- Strength classes C20/25 to C50/60 according to EN 206:2013 + A1:2016.
- Non-cracked concrete: M8 to M30, Rebar Ø8 to Ø32, IG-M6 to IG-M20.
- Cracked concrete: M8 to M30, Rebar Ø8 to Ø32, IG-M6 to IG-M20.

Temperature Range:

- I: - 40 °C to +40 °C (max long term temperature +24 °C and max short term temperature +40 °C)
- II: - 40 °C to +80 °C (max long term temperature +50 °C and max short term temperature +80 °C)
- III: - 40 °C to +120 °C (max long term temperature +72 °C and max short term temperature +120 °C)

Use conditions (Environmental conditions):

- Structures subject to dry internal conditions (all materials).
- For all other conditions according to EN 1993-1-4:2006+A1:2015 corresponding to corrosion resistance class:
 - Stainless steel Stahl A2 according to Annex A 4, Table A1: CRC II
 - Stainless steel Stahl A4 according to Annex A 4, Table A1: CRC III
 - High corrosion resistance steel HCR according to Annex A 4, Table A1: CRC V

Design:

- Verifiable calculation notes and drawings are prepared taking account of the loads to be anchored. The position of the anchor is indicated on the design drawings (e. g. position of the anchor relative to reinforcement or to supports, etc.).
- Anchorages are designed under the responsibility of an engineer experienced in anchorages and concrete work.
- The anchorages are designed in accordance to EN 1992-4:2018 and Technical Report TR055, Edition February 2018

Installation:

- Dry or wet concrete: M8 to M30, Rebar Ø8 to Ø32, IG-M6 to IG-M20.
- Flooded holes (not sea water): M8 to M16, Rebar Ø8 to Ø16, IG-M6 to IG-M10.
- Hole drilling by hammer (HD), hollow (HDB) or compressed air drill mode (CD).
- Overhead installation allowed.
- Anchor installation carried out by appropriately qualified personnel and under the supervision of the person responsible for technical matters of the site.
- The injection mortar is assessed for installation at minimum concrete temperature of -10°C resp. -20°C, where subsequently the temperature in the concrete does not rise at a rapid rate, i.e. from the minimum installation temperature to 24°C within a 12-hour period.

Injection System ESSVE ONE, ESSVE ONE-ICE for concrete	Annex B 1
Intended Use Specifications	

Anchor size		M8	M10	M12	M16	M20	M24	M27	M30
Outer diameter of anchor	d_{nom} [mm] =	8	10	12	16	20	24	27	30
Nominal drill hole diameter	d_0 [mm] =	10	12	14	18	24	28	32	35
Effective embedment depth	$h_{ef,min}$ [mm] =	60	60	70	80	90	96	108	120
	$h_{ef,max}$ [mm] =	160	200	240	320	400	480	540	600
Diameter of clearance hole in the fixture	d_f [mm] ≤	9	12	14	18	22	26	30	33
Diameter of steel brush	d_b [mm] ≥	12	14	16	20	26	30	34	37
Maximum torque moment	T_{inst} [Nm] ≤	10	20	40	80	120	160	180	200
Minimum thickness of member	h_{min} [mm]	$h_{ef} + 30 \text{ mm} \geq 100 \text{ mm}$			$h_{ef} + 2d_0$				
Minimum spacing	s_{min} [mm]	40	50	60	80	100	120	135	150
Minimum edge distance	c_{min} [mm]	40	50	60	80	100	120	135	150



Rebar size		Ø 8	Ø 10	Ø 12	Ø 14	Ø 16	Ø 20	Ø 25	Ø 28	Ø 32
Outer diameter of anchor	d_{nom} [mm] =	8	10	12	14	16	20	25	28	32
Nominal drill hole diameter	d_0 [mm] =	12	14	16	18	20	24	32	35	40
Effective embedment depth	$h_{ef,min}$ [mm] =	60	60	70	75	80	90	100	112	128
	$h_{ef,max}$ [mm] =	160	200	240	280	320	400	500	580	640
Diameter of steel brush	d_b [mm] ≥	14	16	18	20	22	26	34	37	41,5
Minimum thickness of member	h_{min} [mm]	$h_{ef} + 30 \text{ mm} \geq 100 \text{ mm}$			$h_{ef} + 2d_0$					
Minimum spacing	s_{min} [mm]	40	50	60	70	80	100	125	140	160
Minimum edge distance	c_{min} [mm]	40	50	60	70	80	100	125	140	160

Size internal threaded anchor rod		IG-M6	IG-M8	IG-M10	IG-M12	IG-M16	IG-M20
Internal diameter of anchor	d_2 [mm] =	6	8	10	12	16	20
Outer diameter of anchor ¹⁾	d_{nom} [mm] =	10	12	16	20	24	30
Nominal drill hole diameter	d_0 [mm] =	12	14	18	22	28	35
Effective embedment depth	$h_{ef,min}$ [mm] =	60	70	80	90	96	120
	$h_{ef,max}$ [mm] =	200	240	320	400	480	600
Diameter of clearance hole in the fixture	d_f [mm] =	7	9	12	14	18	22
Maximum torque moment	T_{inst} [Nm] ≤	10	10	20	40	60	100
Thread engagement length min/max	l_{IG} [mm] =	8/20	8/20	10/25	12/30	16/32	20/40
Minimum thickness of member	h_{min} [mm]	$h_{ef} + 30 \text{ mm} \geq 100 \text{ mm}$			$h_{ef} + 2d_0$		
Minimum spacing	s_{min} [mm]	50	60	80	100	120	150
Minimum edge distance	c_{min} [mm]	50	60	80	100	120	150

¹⁾ With metric threads according to EN 1993-1-8:2005+AC:2009

Injection System ESSVE ONE, ESSVE ONE-ICE for concrete	Annex B 2
Intended Use Installation parameters	

Table B4: Parameter cleaning and setting tools

Threaded Rod	Rebar	Internal threaded Anchor rod	d_0 Drill bit - \varnothing HD, HDB, CA	d_b Brush - \varnothing		$d_{b,min}$ min. Brush - \varnothing	Piston plug	Installation direction and use of piston plug		
				[mm]	[mm]					
M8			10	RBT10	12	10,5	No piston plug required			
M10	8	IG-M6	12	RBT12	14	12,5				
M12	10	IG-M8	14	RBT14	16	14,5				
	12		16	RBT16	18	16,5				
M16	14	IG-M10	18	RBT18	20	18,5	VS18	$h_{ef} > 250$ mm	$h_{ef} > 250$ mm	all
	16		20	RBT20	22	20,5	VS20			
M20	20	IG-M12	24	RBT24	26	24,5	VS24			
M24		IG-M16	28	RBT28	30	28,5	VS28			
M27	25		32	RBT32	34	32,5	VS32			
M30	28	IG-M20	35	RBT35	37	35,5	VS35			
	32		40	RBT40	41,5	40,5	VS40			



MAC - Hand pump (volume 750 ml)
Drill bit diameter (d_0): 10 mm to 20 mm
Drill hole depth (h_0): $< 10 d_{nom}$
Only in non-cracked concrete



CAC - Rec. compressed air tool (min 6 bar)
Drill bit diameter (d_0): all diameters



Piston plug for overhead or horizontal installation VS
Drill bit diameter (d_0): 18 mm to 40 mm



Steel brush RBT
Drill bit diameter (d_0): all diameters

Injection System ESSVE ONE, ESSVE ONE-ICE for concrete

Intended Use
Cleaning and setting tools

Annex B 3

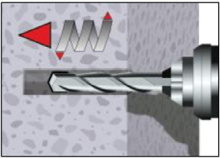
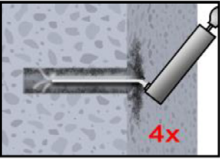
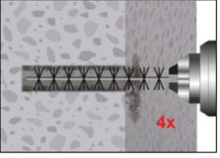
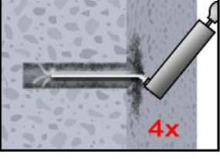
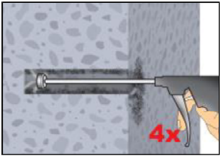
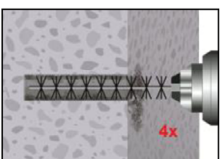
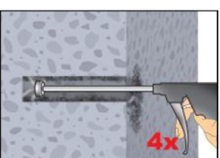
Installation instructions	
Drilling of the bore hole	
	<p>1. Drill with hammer drill a hole into the base material to the size and embedment depth required by the selected anchor (Table B1, B2, or B3), with hammer (HD), hollow (HDB) or compressed air (CD) drilling. The use of a hollow drill bit is only in combination with a sufficient vacuum permitted. In case of aborted drill hole: The drill hole shall be filled with mortar</p>
Attention! Standing water in the bore hole must be removed before cleaning.	
MAC: Cleaning for bore hole diameter $d_0 \leq 20\text{mm}$ and bore hole depth $h_0 \leq 10d_{\text{nom}}$ (uncracked concrete only!)	
	<p>2a. Starting from the bottom or back of the bore hole, blow the hole clean by a hand pump ¹⁾ (Annex B 3) a minimum of four times.</p>
	<p>2b. Check brush diameter (Table B4). Brush the hole with an appropriate sized wire brush $> d_{b,\text{min}}$ (Table B4) a minimum of four times in a twisting motion. If the bore hole ground is not reached with the brush, a brush extension must be used.</p>
	<p>2c. Finally blow the hole clean again with a hand pump (Annex B 3) a minimum of four times.</p> <p>¹⁾ It is permitted to blow bore holes with diameter between 14 mm and 20 mm and an embedment depth up to $10d_{\text{nom}}$ also in cracked concrete with hand-pump.</p>
CAC: Cleaning for all bore hole diameter in uncracked and cracked concrete	
	<p>2a. Starting from the bottom or back of the bore hole, blow the hole clean with compressed air (min. 6 bar) (Annex B 3) a minimum of four times until return air stream is free of noticeable dust. If the bore hole ground is not reached an extension must be used.</p>
	<p>2b. Check brush diameter (Table B4). Brush the hole with an appropriate sized wire brush $> d_{b,\text{min}}$ (Table B4) a minimum of four times in a twisting motion. If the bore hole ground is not reached with the brush, a brush extension must be used.</p>
	<p>2c. Finally blow the hole clean again with compressed air (min. 6 bar) (Annex B 3) a minimum of four times until return air stream is free of noticeable dust. If the bore hole ground is not reached an extension must be used.</p>
After cleaning, the bore hole has to be protected against re-contamination in an appropriate way, until dispensing the mortar in the bore hole. If necessary, the cleaning has to be repeated directly before dispensing the mortar. In-flowing water must not contaminate the bore hole again.	
Injection System ESSVE ONE, ESSVE ONE-ICE for concrete	Annex B 4
Intended Use Installation instructions	

Installation instructions (continuation)

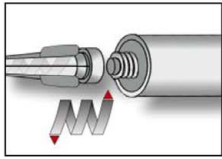

3. Attach the supplied static-mixing nozzle to the cartridge and load the cartridge into the correct dispensing tool. Cut off the foil tube clip before use. For every working interruption longer than the recommended working time (Annex B 6) as well as for new cartridges, a new static-mixer shall be used.

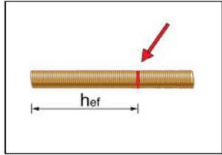

4. Prior to inserting the anchor rod into the filled bore hole, the position of the embedment depth shall be marked on the anchor rods.

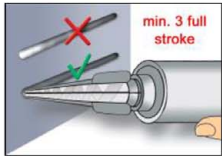

5. Prior to dispensing into the anchor hole, squeeze out separately a minimum of three full strokes and discard non-uniformly mixed adhesive components until the mortar shows a consistent grey colour. For foil tube cartridges it must be discarded a minimum of six full strokes.

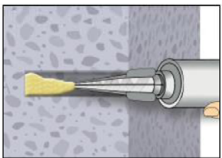

6. Starting from the bottom or back of the cleaned anchor hole, fill the hole up to approximately two-thirds with adhesive. Slowly withdraw the static mixing nozzle as the hole fills to avoid creating air pockets. If the bottom or back of the anchor hole is not reached, an appropriate extension nozzle must be used. Observe the gel-/ working times given in Annex B 6.

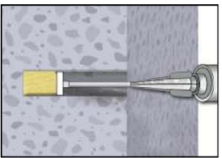

7. Piston plugs and mixer nozzle extensions shall be used according to Table B4 for the following applications:

- Horizontal assembly (horizontal direction) and ground erection (vertical downwards direction): Drill bit- $\varnothing d_0 \geq 18$ mm and embedment depth $h_{ef} > 250$ mm
- Overhead assembly (vertical upwards direction): Drill bit- $\varnothing d_0 \geq 18$ mm

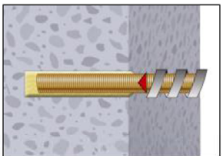

8. Push the threaded rod or reinforcing bar into the anchor hole while turning slightly to ensure positive distribution of the adhesive until the embedment depth is reached.

The anchor shall be free of dirt, grease, oil or other foreign material.

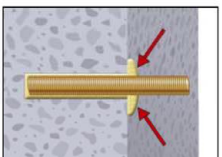

9. Be sure that the anchor is fully seated at the bottom of the hole and that excess mortar is visible at the top of the hole. If these requirements are not maintained, the application has to be renewed. For overhead application the anchor rod shall be fixed (e.g. wedges).

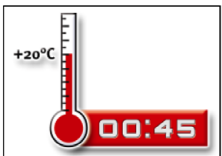

10. Allow the adhesive to cure to the specified time prior to applying any load or torque. Do not move or load the anchor until it is fully cured (attend Annex B 6).

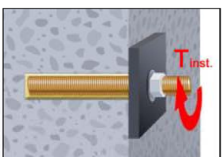

11. After full curing, the add-on part can be installed with up to the max. torque (Table B1 or B3) by using a calibrated torque wrench. It can be optional filled the annular gap between anchor and fixture with mortar. Therefor substitute the washer by the filling washer and connect the mixer reduction nozzle to the tip of the mixer. The annular gap is filled with mortar, when mortar oozes out of the washer.

Injection System ESSVE ONE, ESSVE ONE-ICE for concrete

Intended Use

Installation instructions (continuation)

Annex B 5

**Table B5: Maximum working time and minimum curing time
ESSVE ONE**

Concrete temperature	Gelling- / working time	Minimum curing time in dry concrete ¹⁾
-10 °C to -6°C	90 min ²⁾	24 h ²⁾
-5 °C to -1°C	90 min	14 h
0 °C to +4°C	45 min	7 h
+5 °C to +9°C	25 min	2 h
+ 10 °C to +19°C	15 min	80 min
+ 20 °C to +29°C	6 min	45 min
+ 30 °C to +34°C	4 min	25 min
+ 35 °C to +39°C	2 min	20 min
+ 40 °C	1,5 min	15 min
Cartridge temperature	+5°C to +40°C	

¹⁾ In wet concrete the curing time must be doubled.

²⁾ Cartridge temperature must be at min. +15°C.

**Table B6: Maximum working time and minimum curing time
ESSVE ONE-ICE**

Concrete temperature	Gelling- / working time	Minimum curing time in dry concrete ¹⁾
-20 °C to -16°C	75 min	24 h
-15 °C to -11°C	55 min	16 h
-10 °C to -6°C	35 min	10 h
-5 °C to -1°C	20 min	5 h
0 °C to +4°C	10 min	2,5 h
+5 °C to +9°C	6 min	80 Min
+ 10 °C	6 min	60 Min
Cartridge temperature	-20°C to +10°C	

¹⁾ In wet concrete the curing time must be doubled.

Injection System ESSVE ONE, ESSVE ONE-ICE for concrete	Annex B 6
Intended Use Curing time	

Table C1: Characteristic values for steel tension resistance and steel shear resistance of threaded rods											
Size			M8	M10	M12	M16	M20	M24	M27	M30	
Cross section area	A_s	[mm ²]	36,6	58	84,3	157	245	353	459	561	
Characteristic tension resistance, Steel failure ¹⁾											
Steel, Property class 4.6 and 4.8	$N_{Rk,s}$	[kN]	15 (13)	23 (21)	34	63	98	141	184	224	
Steel, Property class 5.6 and 5.8	$N_{Rk,s}$	[kN]	18 (17)	29 (27)	42	78	122	176	230	280	
Steel, Property class 8.8	$N_{Rk,s}$	[kN]	29 (27)	46 (43)	67	125	196	282	368	449	
Stainless steel A2, A4 and HCR, class 50	$N_{Rk,s}$	[kN]	18	29	42	79	123	177	230	281	
Stainless steel A2, A4 and HCR, class 70	$N_{Rk,s}$	[kN]	26	41	59	110	171	247	-	-	
Stainless steel A4 and HCR, class 80	$N_{Rk,s}$	[kN]	29	46	67	126	196	282	-	-	
Characteristic tension resistance, Partial factor ²⁾											
Steel, Property class 4.6 and 5.6	$\gamma_{Ms,N}$	[-]	2,0								
Steel, Property class 4.8, 5.8 and 8.8	$\gamma_{Ms,N}$	[-]	1,5								
Stainless steel A2, A4 and HCR, class 50	$\gamma_{Ms,N}$	[-]	2,86								
Stainless steel A2, A4 and HCR, class 70	$\gamma_{Ms,N}$	[-]	1,87								
Stainless steel A4 and HCR, class 80	$\gamma_{Ms,N}$	[-]	1,6								
Characteristic shear resistance, Steel failure ¹⁾											
Without lever arm	Steel, Property class 4.6 and 4.8	$V^0_{Rk,s}$	[kN]	9 (8)	14 (13)	20	38	59	85	110	135
	Steel, Property class 5.6 and 5.8	$V^0_{Rk,s}$	[kN]	11 (10)	17 (16)	25	47	74	106	138	168
	Steel, Property class 8.8	$V^0_{Rk,s}$	[kN]	15 (13)	23 (21)	34	63	98	141	184	224
	Stainless steel A2, A4 and HCR, class 50	$V^0_{Rk,s}$	[kN]	9	15	21	39	61	88	115	140
	Stainless steel A2, A4 and HCR, class 70	$V^0_{Rk,s}$	[kN]	13	20	30	55	86	124	-	-
	Stainless steel A4 and HCR, class 80	$V^0_{Rk,s}$	[kN]	15	23	34	63	98	141	-	-
With lever arm	Steel, Property class 4.6 and 4.8	$M^0_{Rk,s}$	[Nm]	15 (13)	30 (27)	52	133	260	449	666	900
	Steel, Property class 5.6 and 5.8	$M^0_{Rk,s}$	[Nm]	19 (16)	37 (33)	65	166	324	560	833	1123
	Steel, Property class 8.8	$M^0_{Rk,s}$	[Nm]	30 (26)	60 (53)	105	266	519	896	1333	1797
	Stainless steel A2, A4 and HCR, class 50	$M^0_{Rk,s}$	[Nm]	19	37	66	167	325	561	832	1125
	Stainless steel A2, A4 and HCR, class 70	$M^0_{Rk,s}$	[Nm]	26	52	92	232	454	784	-	-
	Stainless steel A4 and HCR, class 80	$M^0_{Rk,s}$	[Nm]	30	59	105	266	519	896	-	-
Characteristic shear resistance, Partial factor ²⁾											
Steel, Property class 4.6 and 5.6	$\gamma_{Ms,V}$	[-]	1,67								
Steel, Property class 4.8, 5.8 and 8.8	$\gamma_{Ms,V}$	[-]	1,25								
Stainless steel A2, A4 and HCR, class 50	$\gamma_{Ms,V}$	[-]	2,38								
Stainless steel A2, A4 and HCR, class 70	$\gamma_{Ms,V}$	[-]	1,56								
Stainless steel A4 and HCR, class 80	$\gamma_{Ms,V}$	[-]	1,33								
¹⁾ Values are only valid for the given stress area A_s . Values in brackets are valid for undersized threaded rods with smaller stress area A_s for hot-dip galvanised threaded rods according to EN ISO 10684:2004+AC:2009. ²⁾ in absence of national regulation											
Injection System ESSVE ONE, ESSVE ONE-ICE for concrete									Annex C 1		
Performances Characteristic values for steel tension resistance and steel shear resistance of threaded rods											

Table C2: Characteristic values for Concrete cone failure and Splitting with all kind of action

Anchor size		All Anchor types and sizes		
Concrete cone failure				
Non-cracked concrete		$k_{ucr,N}$	[-]	11,0
Cracked concrete		$k_{cr,N}$	[-]	7,7
Edge distance		$c_{cr,N}$	[mm]	$1,5 h_{ef}$
Axial distance		$s_{cr,N}$	[mm]	$2 c_{cr,N}$
Splitting				
Edge distance	$h/h_{ef} \geq 2,0$	$c_{cr,sp}$	[mm]	$1,0 h_{ef}$
	$2,0 > h/h_{ef} > 1,3$			$2 \cdot h_{ef} \left(2,5 - \frac{h}{h_{ef}} \right)$
	$h/h_{ef} \leq 1,3$			$2,4 h_{ef}$
Axial distance		$s_{cr,sp}$	[mm]	$2 c_{cr,sp}$
Injection System ESSVE ONE, ESSVE ONE-ICE for concrete				Annex C 2
Performances Characteristic values for Concrete cone failure and Splitting with all kind of action				

Table C3: Characteristic values of tension loads under static and quasi-static action													
Anchor size threaded rod				M8	M10	M12	M16	M20	M24	M27	M30		
Steel failure													
Characteristic tension resistance		$N_{Rk,s}$	[kN]	$A_s \cdot f_{uk}$ (or see Table C1)									
Partial factor		$\gamma_{Ms,N}$	[-]	see Table C1									
Combined pull-out and concrete failure													
Characteristic bond resistance in non-cracked concrete C20/25													
Temperature range	I: 40°C/24°C	Dry, wet concrete	$\tau_{Rk,ucr}$	[N/mm ²]	10	12	12	12	12	11	10	9	
	II: 80°C/50°C				7,5	9	9	9	9	8,5	7,5	6,5	
	III: 120°C/72°C				5,5	6,5	6,5	6,5	6,5	6,5	5,5	5,0	
	I: 40°C/24°C	flooded bore hole			7,5	8,5	8,5	8,5	No Performance Assessed (NPA)				
	II: 80°C/50°C				5,5	6,5	6,5	6,5					
	III: 120°C/72°C				4,0	5,0	5,0	5,0					
Characteristic bond resistance in cracked concrete C20/25													
Temperature range	I: 40°C/24°C	Dry, wet concrete	$\tau_{Rk,cr}$	[N/mm ²]	4,0	5,0	5,5	5,5	5,5	5,5	6,5	6,5	
	II: 80°C/50°C				2,5	3,5	4,0	4,0	4,0	4,0	4,5	4,5	
	III: 120°C/72°C				2,0	2,5	3,0	3,0	3,0	3,0	3,5	3,5	
	I: 40°C/24°C	flooded bore hole			4,0	4,0	5,5	5,5	No Performance Assessed (NPA)				
	II: 80°C/50°C				2,5	3,0	4,0	4,0					
	III: 120°C/72°C				2,0	2,5	3,0	3,0					
Reduktion factor ψ_{sus}^0 in cracked and non-cracked concrete C20/25													
Temperature range	I: 40°C/24°C	Dry, wet concrete and flooded bore hole	ψ_{sus}^0	[-]	0,73								
	II: 80°C/50°C				0,65								
	III: 120°C/72°C				0,57								
Increasing factors for concrete ψ_c			C25/30		1,02								
			C30/37		1,04								
			C35/45		1,07								
			C40/50		1,08								
			C45/55		1,09								
			C50/60		1,10								
Concrete cone failure													
Relevant parameter				see Table C2									
Splitting													
Relevant parameter				see Table C2									
Installation factor													
for dry and wet concrete		γ_{inst}	[-]	1,0	1,2								
for flooded bore hole				1,4				NPA					
Injection System ESSVE ONE, ESSVE ONE-ICE for concrete										Annex C 3			
Performances Characteristic values of tension loads under static and quasi-static action													

Table C4: Characteristic values of shear loads under static and quasi-static action											
Anchor size threaded rod			M8	M10	M12	M16	M20	M24	M27	M30	
Steel failure without lever arm											
Characteristic shear resistance Steel, strength class 4.6, 4.8, 5.6 and 5.8	$V_{Rk,s}^0$	[kN]	$0,6 \cdot A_s \cdot f_{uk}$ (or see Table C1)								
Characteristic shear resistance Steel, strength class 8.8 Stainless Steel A2, A4 and HCR, all classes	$V_{Rk,s}^0$	[kN]	$0,5 \cdot A_s \cdot f_{uk}$ (or see Table C1)								
Partial factor	$\gamma_{Ms,V}$	[-]	see Table C1								
Ductility factor	k_7	[-]	1,0								
Steel failure with lever arm											
Characteristic bending moment	$M_{Rk,s}^0$	[Nm]	$1,2 \cdot W_{el} \cdot f_{uk}$ (or see Table C1)								
Elastic section modulus	W_{el}	[mm ³]	31	62	109	277	541	935	1387	1874	
Partial factor	$\gamma_{Ms,V}$	[-]	see Table C1								
Concrete pry-out failure											
Factor	k_8	[-]	2,0								
Installation factor	γ_{inst}	[-]	1,0								
Concrete edge failure											
Effective length of fastener	l_f	[mm]	$\min(h_{ef}; 12 \cdot d_{nom})$						$\min(h_{ef}; 300\text{mm})$		
Outside diameter of fastener	d_{nom}	[mm]	8	10	12	16	20	24	27	30	
Installation factor	γ_{inst}	[-]	1,0								
Injection System ESSVE ONE, ESSVE ONE-ICE for concrete									Annex C 4		
Performances Characteristic values of shear loads under static and quasi-static action											

Table C5: Characteristic values of tension loads under static and quasi-static action											
Anchor size internal threaded anchor rods				IG-M6	IG-M8	IG-M10	IG-M12	IG-M16	IG-M20		
Steel failure¹⁾											
Characteristic tension resistance, Steel, strength class	5.8	$N_{Rk,s}$	[kN]	10	17	29	42	76	123		
	8.8	$N_{Rk,s}$	[kN]	16	27	46	67	121	196		
Partial factor, strength class 5.8 and 8.8		$\gamma_{Ms,N}$	[-]	1,5							
Characteristic tension resistance, Stainless Steel A4 and HCR, Strength class 70 ²⁾		$N_{Rk,s}$	[kN]	14	26	41	59	110	124		
Partial factor		$\gamma_{Ms,N}$	[-]	1,87					2,86		
Combined pull-out and concrete cone failure											
Characteristic bond resistance in non-cracked concrete C20/25											
Temperature range	I: 40°C/24°C	Dry, wet concrete	$\tau_{Rk,ucr}$	[N/mm ²]	12	12	12	12	11	9	
	II: 80°C/50°C				9	9	9	9	8,5	6,5	
	III: 120°C/72°C				6,5	6,5	6,5	6,5	6,5	5,0	
	I: 40°C/24°C	flooded bore hole			8,5	8,5	8,5	No Performance Assessed (NPA)			
	II: 80°C/50°C				6,5	6,5	6,5				
	III: 120°C/72°C				5,0	5,0	5,0				
Characteristic bond resistance in cracked concrete C20/25											
Temperature range	I: 40°C/24°C	Dry, wet concrete	$\tau_{Rk,cr}$	[N/mm ²]	5,0	5,5	5,5	5,5	5,5	6,5	
	II: 80°C/50°C				3,5	4,0	4,0	4,0	4,0	4,5	
	III: 120°C/72°C				2,5	3,0	3,0	3,0	3,0	3,5	
	I: 40°C/24°C	flooded bore hole			4,0	5,5	5,5	No Performance Assessed (NPA)			
	II: 80°C/50°C				3,0	4,0	4,0				
	III: 120°C/72°C				2,5	3,0	3,0				
Reduktion factor ψ_{SUS}^0 in cracked and non-cracked concrete C20/25											
Temperature range	I: 40°C/24°C	Dry, wet concrete and flooded bore hole	ψ_{SUS}^0	[-]	0,73						
	II: 80°C/50°C				0,65						
	III: 120°C/72°C				0,57						
Increasing factors for concrete ψ_c				C25/30	1,02						
				C30/37	1,04						
				C35/45	1,07						
				C40/50	1,08						
				C45/55	1,09						
				C50/60	1,10						
Concrete cone failure											
Relevant parameter				see Table C2							
Splitting failure											
Relevant parameter				see Table C2							
Installation factor											
for dry and wet concrete			γ_{inst}	[-]	1,2						
for flooded bore hole					1,4			NPA			
¹⁾ Fastenings (incl. nut and washer) must comply with the appropriate material and property class of the internal threaded rod. The characteristic tension resistance for steel failure is valid for the internal threaded rod and the fastening element. ²⁾ For IG-M20 strength class 50 is valid											
Injection System ESSVE ONE, ESSVE ONE-ICE for concrete								Annex C 5			
Performances Characteristic values of tension loads under static and quasi-static action											

Table C6: Characteristic values of shear loads under static and quasi-static action									
Anchor size for internal threaded anchor rods				IG-M6	IG-M8	IG-M10	IG-M12	IG-M16	IG-M20
Steel failure without lever arm¹⁾									
Characteristic shear resistance, Steel, strength class	5.8	$V_{Rk,s}^0$	[kN]	5	9	15	21	38	61
	8.8	$V_{Rk,s}^0$	[kN]	8	14	23	34	60	98
Partial factor, strength class 5.8 and 8.8	$\gamma_{Ms,V}$	[-]	1,25						
Characteristic shear resistance, Stainless Steel A4 and HCR, Strength class 70 ²⁾		$V_{Rk,s}^0$	[kN]	7	13	20	30	55	40
	Partial factor	$\gamma_{Ms,V}$	[-]	1,56					2,38
Ductility factor	k_7	[-]	1,0						
Steel failure with lever arm¹⁾									
Characteristic bending moment, Steel, strength class	5.8	$M_{Rk,s}^0$	[Nm]	8	19	37	66	167	325
	8.8	$M_{Rk,s}^0$	[Nm]	12	30	60	105	267	519
Partial factor, strength class 5.8 and 8.8	$\gamma_{Ms,V}$	[-]	1,25						
Characteristic bending moment, Stainless Steel A4 and HCR, Strength class 70 ²⁾		$M_{Rk,s}^0$	[Nm]	11	26	52	92	233	456
	Partial factor	$\gamma_{Ms,V}$	[-]	1,56					2,38
Concrete pry-out failure									
Factor	k_8	[-]	2,0						
Installation factor	γ_{inst}	[-]	1,0						
Concrete edge failure									
Effective length of fastener	l_f	[mm]	$\min(h_{ef}; 12 \cdot d_{nom})$						$\min(h_{ef}; 300\text{mm})$
Outside diameter of fastener	d_{nom}	[mm]	10	12	16	20	24	30	
Installation factor	γ_{inst}	[-]	1,0						
¹⁾ Fastenings (incl. nut and washer) must comply with the appropriate material and property class of the internal threaded rod. The characteristic tension resistance for steel failure is valid for the internal threaded rod and the fastening element. ²⁾ For IG-M20 strength class 50 is valid									
Injection System ESSVE ONE, ESSVE ONE-ICE for concrete								Annex C 6	
Performances Characteristic values of shear loads under static and quasi-static action									

Table C7: Characteristic values of tension loads under static and quasi-static action														
Anchor size reinforcing bar			Ø 8	Ø 10	Ø 12	Ø 14	Ø 16	Ø 20	Ø 25	Ø 28	Ø 32			
Steel failure														
Characteristic tension resistance	$N_{Rk,s}$	[kN]	$A_s \cdot f_{uk}^{1)}$											
Cross section area	A_s	[mm ²]	50	79	113	154	201	314	491	616	804			
Partial factor	$\gamma_{Ms,N}$	[-]	1,4 ²⁾											
Combined pull-out and concrete failure														
Characteristic bond resistance in non-cracked concrete C20/25														
Temperature range	I: 40°C/24°C	Dry, wet concrete	$\tau_{Rk,ucr}$	[N/mm ²]	10	12	12	12	12	12	11	10	8,5	
	II: 80°C/50°C				7,5	9	9	9	9	9	8,0	7,0	6,0	
	III: 120°C/72°C				5,5	6,5	6,5	6,5	6,5	6,5	6,0	5,0	4,5	
	I: 40°C/24°C	flooded bore hole			7,5	8,5	8,5	8,5	8,5	No Performance Assessed (NPA)				
	II: 80°C/50°C				5,5	6,5	6,5	6,5	6,5					
	III: 120°C/72°C				4,0	5,0	5,0	5,0	5,0					
Characteristic bond resistance in cracked concrete C20/25														
Temperature range	I: 40°C/24°C	Dry, wet concrete	$\tau_{Rk,cr}$	[N/mm ²]	4,0	5,0	5,5	5,5	5,5	5,5	5,5	6,5	6,5	
	II: 80°C/50°C				2,5	3,5	4,0	4,0	4,0	4,0	4,0	4,5	4,5	
	III: 120°C/72°C				2,0	2,5	3,0	3,0	3,0	3,0	3,0	3,5	3,5	
	I: 40°C/24°C	flooded bore hole			4,0	4,0	5,5	5,5	5,5	No Performance Assessed (NPA)				
	II: 80°C/50°C				2,5	3,0	4,0	4,0	4,0					
	III: 120°C/72°C				2,0	2,5	3,0	3,0	3,0					
Reduktion factor ψ_{sus}^0 in cracked and non-cracked concrete C20/25														
Temperature range	I: 40°C/24°C	Dry, wet concrete and flooded bore hole	ψ_{sus}^0	[-]	0,73									
	II: 80°C/50°C				0,65									
	III: 120°C/72°C				0,57									
Increasing factors for concrete ψ_c				C25/30	1,02									
				C30/37	1,04									
				C35/45	1,07									
				C40/50	1,08									
				C45/55	1,09									
				C50/60	1,10									
Concrete cone failure														
Relevant parameter			see Table C2											
Splitting														
Relevant parameter			see Table C2											
Installation factor														
for dry and wet concrete		γ_{inst}	[-]	1,2	1,2									
for flooded bore hole				1,4					NPA					
¹⁾ f_{uk} shall be taken from the specifications of reinforcing bars ²⁾ in absence of national regulation														
Injection System ESSVE ONE, ESSVE ONE-ICE for concrete										Annex C 7				
Performances Characteristic values of tension loads under static and quasi-static action														

Table C8: Characteristic values of shear loads under static and quasi-static action													
Anchor size reinforcing bar			Ø 8	Ø 10	Ø 12	Ø 14	Ø 16	Ø 20	Ø 25	Ø 28	Ø 32		
Steel failure without lever arm													
Characteristic shear resistance	$V_{Rk,s}^0$	[kN]	$0,50 \cdot A_s \cdot f_{uk}^{1)}$										
Cross section area	A_s	[mm ²]	50	79	113	154	201	314	491	616	804		
Partial factor	$\gamma_{Ms,V}$	[-]	1,5 ²⁾										
Ductility factor	k_7	[-]	1,0										
Steel failure with lever arm													
Characteristic bending moment	$M_{Rk,s}^0$	[Nm]	$1,2 \cdot W_{el} \cdot f_{uk}^{1)}$										
Elastic section modulus	W_{el}	[mm ³]	50	98	170	269	402	785	1534	2155	3217		
Partial factor	$\gamma_{Ms,V}$	[-]	1,5 ²⁾										
Concrete pry-out failure													
Factor	k_8	[-]	2,0										
Installation factor	γ_{inst}	[-]	1,0										
Concrete edge failure													
Effective length of fastener	l_f	[mm]	$\min(h_{ef}; 12 \cdot d_{nom})$						$\min(h_{ef}; 300\text{mm})$				
Outside diameter of fastener	d_{nom}	[mm]	8	10	12	14	16	20	25	28	32		
Installation factor	γ_{inst}	[-]	1,0										
¹⁾ f_{uk} shall be taken from the specifications of reinforcing bars ²⁾ in absence of national regulation													
Injection System ESSVE ONE, ESSVE ONE-ICE for concrete									Annex C 8				
Performances Characteristic values of shear loads under static and quasi-static action													

Table C9: Displacements under tension load¹⁾ (threaded rod)											
Anchor size threaded rod			M8	M10	M12	M16	M20	M24	M27	M30	
Non-cracked concrete C20/25 under static and quasi-static action											
Temperature range I: 40°C/24°C	δ_{N0} -factor	[mm/(N/mm ²)]	0,021	0,023	0,026	0,031	0,036	0,041	0,045	0,049	
	$\delta_{N\infty}$ -factor	[mm/(N/mm ²)]	0,030	0,033	0,037	0,045	0,052	0,060	0,065	0,071	
Temperature range II: 80°C/50°C	δ_{N0} -factor	[mm/(N/mm ²)]	0,050	0,056	0,063	0,075	0,088	0,100	0,110	0,119	
	$\delta_{N\infty}$ -factor	[mm/(N/mm ²)]	0,072	0,081	0,090	0,108	0,127	0,145	0,159	0,172	
Temperature range III: 120°C/72°C	δ_{N0} -factor	[mm/(N/mm ²)]	0,050	0,056	0,063	0,075	0,088	0,100	0,110	0,119	
	$\delta_{N\infty}$ -factor	[mm/(N/mm ²)]	0,072	0,081	0,090	0,108	0,127	0,145	0,159	0,172	
Cracked concrete C20/25 under static and quasi-static action											
Temperature range I: 40°C/24°C	δ_{N0} -factor	[mm/(N/mm ²)]	0,090				0,070				
	$\delta_{N\infty}$ -factor	[mm/(N/mm ²)]	0,105				0,105				
Temperature range II: 80°C/50°C	δ_{N0} -factor	[mm/(N/mm ²)]	0,219				0,170				
	$\delta_{N\infty}$ -factor	[mm/(N/mm ²)]	0,255				0,245				
Temperature range III: 120°C/72°C	δ_{N0} -factor	[mm/(N/mm ²)]	0,219				0,170				
	$\delta_{N\infty}$ -factor	[mm/(N/mm ²)]	0,255				0,245				
¹⁾ Calculation of the displacement $\delta_{N0} = \delta_{N0}$ -factor $\cdot \tau$; τ : action bond stress for tension $\delta_{N\infty} = \delta_{N\infty}$ -factor $\cdot \tau$;											
Table C10: Displacements under shear load¹⁾ (threaded rod)											
Anchor size threaded rod			M8	M10	M12	M16	M20	M24	M27	M30	
Non-cracked concrete C20/25 under static and quasi-static action											
All temperature ranges	δ_{V0} -factor	[mm/kN]	0,06	0,06	0,05	0,04	0,04	0,03	0,03	0,03	
	$\delta_{V\infty}$ -factor	[mm/kN]	0,09	0,08	0,08	0,06	0,06	0,05	0,05	0,05	
Cracked concrete C20/25 under static and quasi-static action											
All temperature ranges	δ_{V0} -factor	[mm/kN]	0,12	0,12	0,11	0,10	0,09	0,08	0,08	0,07	
	$\delta_{V\infty}$ -factor	[mm/kN]	0,18	0,18	0,17	0,15	0,14	0,13	0,12	0,10	
¹⁾ Calculation of the displacement $\delta_{V0} = \delta_{V0}$ -factor $\cdot V$; V : action shear load $\delta_{V\infty} = \delta_{V\infty}$ -factor $\cdot V$;											
Injection System ESSVE ONE, ESSVE ONE-ICE for concrete								Annex C 9			
Performances Displacements (threaded rods)											

Table C11: Displacements under tension load¹⁾ (Internal threaded anchor rod)								
Anchor size Internal threaded anchor rod			IG-M6	IG-M8	IG-M10	IG-M12	IG-M16	IG-M20
Non-cracked concrete C20/25 under static and quasi-static action								
Temperature range I: 40°C/24°C	δ_{N0} -factor	[mm/(N/mm ²)]	0,023	0,026	0,031	0,036	0,041	0,049
	$\delta_{N\infty}$ -factor	[mm/(N/mm ²)]	0,033	0,037	0,045	0,052	0,060	0,071
Temperature range II: 80°C/50°C	δ_{N0} -factor	[mm/(N/mm ²)]	0,056	0,063	0,075	0,088	0,100	0,119
	$\delta_{N\infty}$ -factor	[mm/(N/mm ²)]	0,081	0,090	0,108	0,127	0,145	0,172
Temperature range III: 120°C/72°C	δ_{N0} -factor	[mm/(N/mm ²)]	0,056	0,063	0,075	0,088	0,100	0,119
	$\delta_{N\infty}$ -factor	[mm/(N/mm ²)]	0,081	0,090	0,108	0,127	0,145	0,172
Cracked concrete C20/25 under static and quasi-static action								
Temperature range I: 40°C/24°C	δ_{N0} -factor	[mm/(N/mm ²)]	0,090	0,070				
	$\delta_{N\infty}$ -factor	[mm/(N/mm ²)]	0,105	0,105				
Temperature range II: 80°C/50°C	δ_{N0} -factor	[mm/(N/mm ²)]	0,219	0,170				
	$\delta_{N\infty}$ -factor	[mm/(N/mm ²)]	0,255	0,245				
Temperature range III: 120°C/72°C	δ_{N0} -factor	[mm/(N/mm ²)]	0,219	0,170				
	$\delta_{N\infty}$ -factor	[mm/(N/mm ²)]	0,255	0,245				
¹⁾ Calculation of the displacement $\delta_{N0} = \delta_{N0}\text{-factor} \cdot \tau$; τ : action bond stress for tension $\delta_{N\infty} = \delta_{N\infty}\text{-factor} \cdot \tau$;								
Table C12: Displacements under shear load¹⁾ (Internal threaded anchor rod)								
Anchor size Internal threaded anchor rod			IG-M6	IG-M8	IG-M10	IG-M12	IG-M16	IG-M20
Non-cracked and cracked concrete C20/25 under static and quasi-static action								
All temperature ranges	δ_{V0} -factor	[mm/kN]	0,07	0,06	0,06	0,05	0,04	0,04
	$\delta_{V\infty}$ -factor	[mm/kN]	0,10	0,09	0,08	0,08	0,06	0,06
¹⁾ Calculation of the displacement $\delta_{V0} = \delta_{V0}\text{-factor} \cdot V$; V : action shear load $\delta_{V\infty} = \delta_{V\infty}\text{-factor} \cdot V$;								
Injection System ESSVE ONE, ESSVE ONE-ICE for concrete							Annex C 10	
Performances Displacements (Internal threaded anchor rod)								

Table C13: Displacements under tension load¹⁾ (rebar)											
Anchor size reinforcing bar			Ø 8	Ø 10	Ø 12	Ø 14	Ø 16	Ø 20	Ø 25	Ø 28	Ø 32
Non-cracked concrete C20/25 under static and quasi-static action											
Temperature range I: 40°C/24°C	δ_{N0} -factor	[mm/(N/mm ²)]	0,021	0,023	0,026	0,028	0,031	0,036	0,043	0,047	0,052
	$\delta_{N\infty}$ -factor	[mm/(N/mm ²)]	0,030	0,033	0,037	0,041	0,045	0,052	0,061	0,071	0,075
Temperature range II: 80°C/50°C	δ_{N0} -factor	[mm/(N/mm ²)]	0,050	0,056	0,063	0,069	0,075	0,088	0,104	0,113	0,126
	$\delta_{N\infty}$ -factor	[mm/(N/mm ²)]	0,072	0,081	0,090	0,099	0,108	0,127	0,149	0,163	0,181
Temperature range III: 120°C/72°C	δ_{N0} -factor	[mm/(N/mm ²)]	0,050	0,056	0,063	0,069	0,075	0,088	0,104	0,113	0,126
	$\delta_{N\infty}$ -factor	[mm/(N/mm ²)]	0,072	0,081	0,090	0,099	0,108	0,127	0,149	0,163	0,181
Cracked concrete C20/25 under static and quasi-static action											
Temperature range I: 40°C/24°C	δ_{N0} -factor	[mm/(N/mm ²)]	0,090				0,070				
	$\delta_{N\infty}$ -factor	[mm/(N/mm ²)]	0,105				0,105				
Temperature range II: 80°C/50°C	δ_{N0} -factor	[mm/(N/mm ²)]	0,219				0,170				
	$\delta_{N\infty}$ -factor	[mm/(N/mm ²)]	0,255				0,245				
Temperature range III: 120°C/72°C	δ_{N0} -factor	[mm/(N/mm ²)]	0,219				0,170				
	$\delta_{N\infty}$ -factor	[mm/(N/mm ²)]	0,255				0,245				
¹⁾ Calculation of the displacement $\delta_{N0} = \delta_{N0}\text{-factor} \cdot \tau;$ τ : action bond stress for tension $\delta_{N\infty} = \delta_{N\infty}\text{-factor} \cdot \tau;$											
Table C14: Displacement under shear load¹⁾ (rebar)											
Anchor size reinforcing bar			Ø 8	Ø 10	Ø 12	Ø 14	Ø 16	Ø 20	Ø 25	Ø 28	Ø 32
Non-cracked concrete C20/25 under static and quasi-static action											
All temperature ranges	δ_{V0} -factor	[mm/kN]	0,06	0,05	0,05	0,04	0,04	0,04	0,03	0,03	0,03
	$\delta_{V\infty}$ -factor	[mm/kN]	0,09	0,08	0,08	0,06	0,06	0,05	0,05	0,04	0,04
Cracked concrete C20/25 under static and quasi-static action											
All temperature ranges	δ_{V0} -factor	[mm/kN]	0,12	0,12	0,11	0,11	0,10	0,09	0,08	0,07	0,06
	$\delta_{V\infty}$ -factor	[mm/kN]	0,18	0,18	0,17	0,16	0,15	0,14	0,12	0,11	0,10
¹⁾ Calculation of the displacement $\delta_{V0} = \delta_{V0}\text{-factor} \cdot V;$ V : action shear load $\delta_{V\infty} = \delta_{V\infty}\text{-factor} \cdot V;$											
Injection System ESSVE ONE, ESSVE ONE-ICE for concrete									Annex C 11		
Performances Displacements (rebar)											

Table C15: Characteristic values of tension loads under seismic action (performance category C1)													
Anchor size threaded rod				M8	M10	M12	M16	M20	M24	M27	M30		
Steel failure													
Characteristic tension resistance		$N_{Rk,s,eq}$	[kN]	$1,0 \cdot N_{Rk,s}$									
Partial factor		$\gamma_{Ms,N}$	[-]	see Table C1									
Combined pull-out and concrete failure													
Characteristic bond resistance in non-cracked and cracked concrete C20/25													
Temperature range	I: 40°C/24°C	Dry, wet concrete	$\tau_{Rk,eq}$	[N/mm ²]	2,5	3,1	3,7	3,7	3,7	3,8	4,5	4,5	
	II: 80°C/50°C				1,6	2,2	2,7	2,7	2,7	2,8	3,1	3,1	
	III: 120°C/72°C				1,3	1,6	2,0	2,0	2,0	2,1	2,4	2,4	
	I: 40°C/24°C	flooded bore hole			2,5	2,5	3,7	3,7	No Performance Assessed (NPA)				
	II: 80°C/50°C				1,6	1,9	2,7	2,7					
	III: 120°C/72°C				1,3	1,6	2,0	2,0					
Reduktion factor ψ_{SUS}^0 in cracked and non-cracked concrete C20/25													
Temperature range	I: 40°C/24°C	Dry, wet concrete and flooded bore hole	ψ_{SUS}^0	[-]	0,73								
	II: 80°C/50°C				0,65								
	III: 120°C/72°C				0,57								
Increasing factors for concrete ψ_c			C25/30 to C50/60				1,0						
Concrete cone failure													
Relevant parameter				see Table C2									
Splitting													
Relevant parameter				see Table C2									
Installation factor													
for dry and wet concrete		γ_{inst}	[-]	1,0	1,2								
for flooded bore hole				1,4				NPA					
Injection System ESSVE ONE, ESSVE ONE-ICE for concrete										Annex C 12			
Performances Characteristic values of tension loads under seismic action (performance category C1)													

Table C16: Characteristic values of shear loads under seismic action (performance category C1)											
Anchor size threaded rod			M8	M10	M12	M16	M20	M24	M27	M30	
Steel failure without lever arm											
Characteristic shear resistance (Seismic C1)	$V_{Rk,s,eq}$	[kN]	$0,70 \cdot V^0_{Rk,s}$								
Partial factor	$\gamma_{Ms,V}$	[-]	see Table C1								
Ductility factor	k_7	[-]	1,0								
Steel failure with lever arm											
Characteristic bending moment	$M^0_{Rk,s,eq}$	[Nm]	No Performance Assessed (NPA)								
Concrete pry-out failure											
Factor	k_8	[-]	2,0								
Installation factor	γ_{inst}	[-]	1,0								
Concrete edge failure											
Effective length of fastener	l_f	[mm]	$\min(h_{ef}; 12 \cdot d_{nom})$						$\min(h_{ef}; 300\text{mm})$		
Outside diameter of fastener	d_{nom}	[mm]	8	10	12	16	20	24	27	30	
Installation factor	γ_{inst}	[-]	1,0								
Factor for annular gap	α_{gap}	[-]	$0,5 (1,0)^1$								
¹⁾ Value in brackets valid for filled annular gap between anchor and clearance hole in the fixture. Use of special filling washer Annex A 3 is required											
Injection System ESSVE ONE, ESSVE ONE-ICE for concrete								Annex C 13			
Performances		Characteristic values of shear loads under seismic action (performance category C1)									

Table C17: Characteristic values of tension loads under seismic action (performance category C1)															
Anchor size reinforcing bar			Ø 8	Ø 10	Ø 12	Ø 14	Ø 16	Ø 20	Ø 25	Ø 28	Ø 32				
Steel failure															
Characteristic tension resistance	$N_{Rk,s,eq}$	[kN]	$1,0 \cdot A_s \cdot f_{uk}^{1)}$												
Cross section area	A_s	[mm ²]	50	79	113	154	201	314	491	616	804				
Partial factor	$\gamma_{Ms,N}$	[-]	$1,4^{2)}$												
Combined pull-out and concrete failure															
Characteristic bond resistance in non-cracked and cracked concrete C20/25															
Temperature range	I: 40°C/24°C	Dry, wet concrete	$\tau_{Rk, eq}$	[N/mm ²]	2,5	3,1	3,7	3,7	3,7	3,7	3,8	4,5	4,5		
	II: 80°C/50°C				1,6	2,2	2,7	2,7	2,7	2,7	2,8	3,1	3,1		
	III: 120°C/72°C				1,3	1,6	2,0	2,0	2,0	2,0	2,1	2,4	2,4		
	I: 40°C/24°C	flooded bore hole			2,5	2,5	3,7	3,7	3,7	No Performance Assessed (NPA)					
	II: 80°C/50°C				1,6	1,9	2,7	2,7	2,7						
	III: 120°C/72°C				1,3	1,6	2,0	2,0	2,0						
Reduktion factor ψ_{SUS}^0 in cracked and non-cracked concrete C20/25															
Temperature range	I: 40°C/24°C	Dry, wet concrete and flooded bore hole	ψ_{SUS}^0	[-]	0,73										
	II: 80°C/50°C				0,65										
	III: 120°C/72°C				0,57										
Increasing factors for concrete ψ_c			C25/30 to C50/60				1,0								
Concrete cone failure															
Relevant parameter			see Table C2												
Splitting															
Relevant parameter			see Table C2												
Installation factor															
for dry and wet concrete			γ_{inst}	[-]	1,2	1,2									
for flooded bore hole					1,4				NPA						
¹⁾ f_{uk} shall be taken from the specifications of reinforcing bars ²⁾ in absence of national regulation															
Injection System ESSVE ONE, ESSVE ONE-ICE for concrete										Annex C 14					
Performances Characteristic values of tension loads under seismic action (performance category C1)															

Table C18: Characteristic values of shear loads under seismic action (performance category C1)											
Anchor size reinforcing bar		Ø 8	Ø 10	Ø 12	Ø 14	Ø 16	Ø 20	Ø 25	Ø 28	Ø 32	
Steel failure without lever arm											
Characteristic shear resistance	$V_{Rk,s,eq}$	[kN]	$0,35 \cdot A_s \cdot f_{uk}^{2)}$								
Cross section area	A_s	[mm ²]	50	79	113	154	201	314	491	616	804
Partial factor	$\gamma_{Ms,V}$	[-]	1,5 ²⁾								
Ductility factor	k_7	[-]	1,0								
Steel failure with lever arm											
Characteristic bending moment	$M^0_{Rk,s,eq}$	[Nm]	No Performance Assessed (NPA)								
Concrete pry-out failure											
Factor	k_8	[-]	2,0								
Installation factor	γ_{inst}	[-]	1,0								
Concrete edge failure											
Effective length of fastener	l_f	[mm]	$\min(h_{ef}; 12 \cdot d_{nom})$						$\min(h_{ef}; 300\text{mm})$		
Outside diameter of fastener	d_{nom}	[mm]	8	10	12	14	16	20	25	28	32
Installation factor	γ_{inst}	[-]	1,0								
Factor for annular gap	α_{gap}	[-]	$0,5 (1,0)^{3)}$								
¹⁾ f_{uk} shall be taken from the specifications of reinforcing bars ²⁾ in absence of national regulation ³⁾ Value in brackets valid for filled annular gap between anchor and clearance hole in the fixture. Use of special filling washer Annex A 3 is required											
Injection System ESSVE ONE, ESSVE ONE-ICE for concrete										Annex C 15	
Performances Characteristic values of shear loads under seismic action (performance category C1)											

Table C19: Displacements under tension load¹⁾ (threaded rod)											
Anchor size threaded rod			M8	M10	M12	M16	M20	M24	M27	M30	
Cracked and non-cracked concrete C20/25 under seismic C1 action											
Temperature range I: 40°C/24°C	δ_{N0} -factor	[mm/(N/mm ²)]	0,090				0,070				
	$\delta_{N\infty}$ -factor	[mm/(N/mm ²)]	0,105				0,105				
Temperature range II: 80°C/50°C	δ_{N0} -factor	[mm/(N/mm ²)]	0,219				0,170				
	$\delta_{N\infty}$ -factor	[mm/(N/mm ²)]	0,255				0,245				
Temperature range III: 120°C/72°C	δ_{N0} -factor	[mm/(N/mm ²)]	0,219				0,170				
	$\delta_{N\infty}$ -factor	[mm/(N/mm ²)]	0,255				0,245				
Table C20: Displacements under tension load¹⁾ (rebar)											
Anchor size reinforcing bar			Ø 8	Ø 10	Ø 12	Ø 14	Ø 16	Ø 20	Ø 25	Ø 28	Ø 32
Cracked and non-cracked concrete C20/25 under seismic C1 action											
Temperature range I: 40°C/24°C	δ_{N0} -factor	[mm/(N/mm ²)]	0,090				0,070				
	$\delta_{N\infty}$ -factor	[mm/(N/mm ²)]	0,105				0,105				
Temperature range II: 80°C/50°C	δ_{N0} -factor	[mm/(N/mm ²)]	0,219				0,170				
	$\delta_{N\infty}$ -factor	[mm/(N/mm ²)]	0,255				0,245				
Temperature range III: 120°C/72°C	δ_{N0} -factor	[mm/(N/mm ²)]	0,219				0,170				
	$\delta_{N\infty}$ -factor	[mm/(N/mm ²)]	0,255				0,245				
¹⁾ Calculation of the displacement $\delta_{N0} = \delta_{N0}$ -factor $\cdot \tau$; τ : action bond stress for tension $\delta_{N\infty} = \delta_{N\infty}$ -factor $\cdot \tau$;											
Table C21: Displacements under shear load²⁾ (threaded rod)											
Anchor size threaded rod			M8	M10	M12	M16	M20	M24	M27	M30	
Cracked and non-cracked concrete C20/25 under seismic C1 action											
All temperature ranges	δ_{V0} -factor	[mm/kN]	0,12	0,12	0,11	0,10	0,09	0,08	0,08	0,07	
	$\delta_{V\infty}$ -factor	[mm/kN]	0,18	0,18	0,17	0,15	0,14	0,13	0,12	0,10	
Table C22: Displacement under shear load¹⁾ (rebar)											
Anchor size reinforcing bar			Ø 8	Ø 10	Ø 12	Ø 14	Ø 16	Ø 20	Ø 25	Ø 28	Ø 32
Cracked and non-cracked concrete C20/25 under seismic C1 action											
All temperature ranges	δ_{V0} -factor	[mm/kN]	0,12	0,12	0,11	0,11	0,10	0,09	0,08	0,07	0,06
	$\delta_{V\infty}$ -factor	[mm/kN]	0,18	0,18	0,17	0,16	0,15	0,14	0,12	0,11	0,10
¹⁾ Calculation of the displacement $\delta_{V0} = \delta_{V0}$ -factor $\cdot V$; V: action shear load $\delta_{V\infty} = \delta_{V\infty}$ -factor $\cdot V$;											
Injection System ESSVE ONE, ESSVE ONE-ICE for concrete									Annex C 16		
Performances Displacements under seismic C1 action (threaded rods and rebar)											

Approval body for construction products
and types of construction

Bautechnisches Prüfamt

An institution established by the Federal and
Laender Governments



European Technical Assessment

ETA-18/0642
of 8 October 2018

English translation prepared by DIBt - Original version in German language

General Part

Technical Assessment Body issuing the
European Technical Assessment:

Deutsches Institut für Bautechnik

Trade name of the construction product

ESSVE Injection system ONE or ONE ICE for Masonry

Product family
to which the construction product belongs

Metal Injection anchors for use in masonry

Manufacturer

ESSVE Produkter AB
Esbogatan 14
164 74 KISTA
SCHWEDEN

Manufacturing plant

ESSVE Plant No. 671

This European Technical Assessment
contains

61 pages including 3 annexes which form an integral part
of this assessment

This European Technical Assessment is
issued in accordance with Regulation (EU)
No 305/2011, on the basis of

EAD 330076-00-0604

The European Technical Assessment is issued by the Technical Assessment Body in its official language. Translations of this European Technical Assessment in other languages shall fully correspond to the original issued document and shall be identified as such.

Communication of this European Technical Assessment, including transmission by electronic means, shall be in full. However, partial reproduction may only be made with the written consent of the issuing Technical Assessment Body. Any partial reproduction shall be identified as such.

This European Technical Assessment may be withdrawn by the issuing Technical Assessment Body, in particular pursuant to information by the Commission in accordance with Article 25(3) of Regulation (EU) No 305/2011.

Specific Part

1 Technical description of the product

The ESSVE Injection System ONE or ONE ICE for masonry is a bonded anchor (injection type) consisting of a mortar cartridge with injection mortar ESSVE ONE or ESSVE ONE ICE, a perforated sleeve and an anchor rod with hexagon nut and washer. The steel elements are made of zinc coated steel or stainless steel.

The anchor rod is placed into a drilled hole filled with injection mortar and is anchored via the bond between steel element, injection mortar and masonry and mechanical interlock.

The product description is given in Annex A.

2 Specification of the intended use in accordance with the applicable European Assessment Document

The performances given in Section 3 are only valid if the anchor is used in compliance with the specifications and conditions given in Annex B.

The verifications and assessment methods on which this European Technical Assessment is based lead to the assumption of a working life of the anchor of at least 50 years. The indications given on the working life cannot be interpreted as a guarantee given by the producer, but are to be regarded only as a means for choosing the right products in relation to the expected economically reasonable working life of the works.

3 Performance of the product and references to the methods used for its assessment

3.1 Mechanical resistance and stability (BWR 1)

Essential characteristic	Performance
Characteristic values for resistance	See Annexes C 1 to C 45
Displacements	See Annex C 5 to C 45

3.2 Safety in case of fire (BWR 2)

Essential characteristic	Performance
Reaction to fire	Class A1

3.3 Hygiene, health and the environment (BWR 3)

Essential characteristic	Performance
Content, emission and/or release of dangerous substances	No performance assessed

4 Assessment and verification of constancy of performance (AVCP) system applied, with reference to its legal base

In accordance with the European Assessment Document EAD 330076-00-0604 the applicable European legal act is: [97/177/EC].

The system to be applied is: 1

5 Technical details necessary for the implementation of the AVCP system, as provided for in the applicable European Assessment Document

Technical details necessary for the implementation of the AVCP system are laid down in the control plan deposited at Deutsches Institut für Bautechnik.

Issued in Berlin on 8 October 2018 by Deutsches Institut für Bautechnik

Dr.-Ing. Lars Eckfeldt
p.p. Head of Department

beglaubigt:
Baderschneider

Installation in hollow brick; threaded rod and Internal threaded rod with sleeve

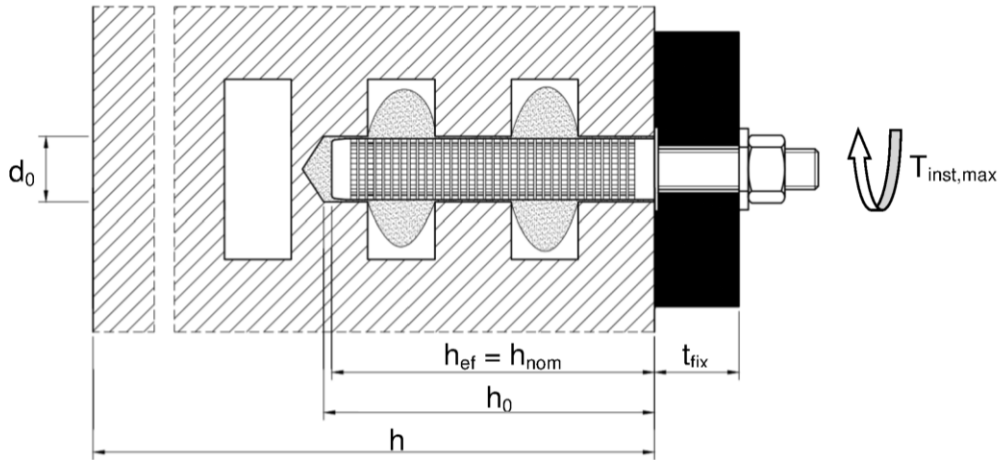

Installation in solid brick; threaded rod and Internal threaded rod with sleeve

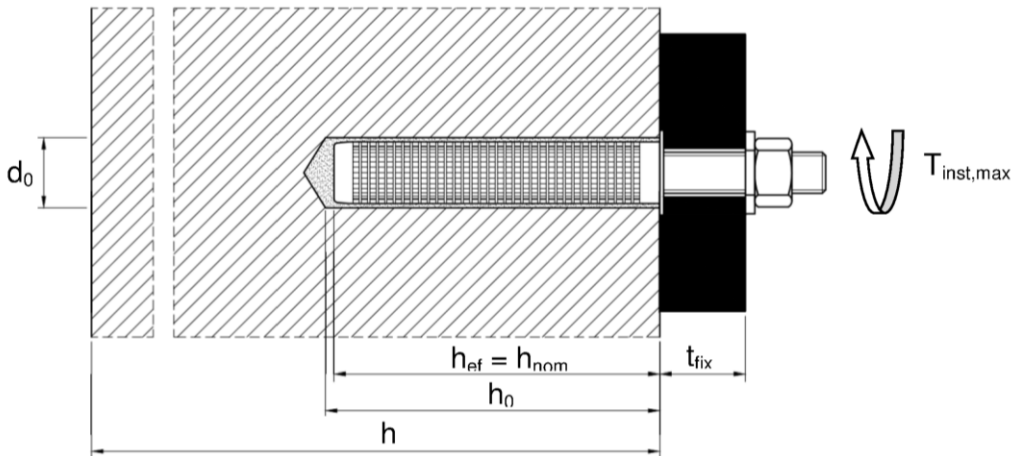

Installation in solid brick; threaded rod and Internal threaded rod without sleeve

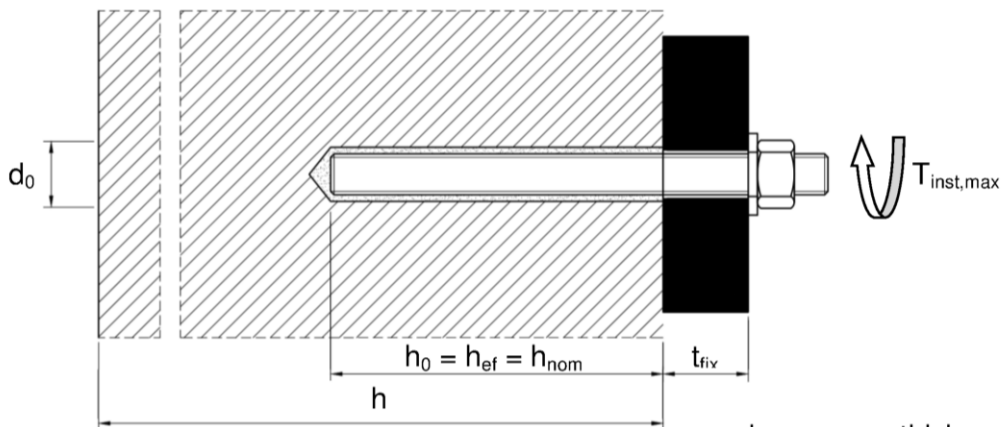

d_0 = nominal drill hole diameter
 t_{fix} = thickness of fixture
 $T_{inst,max}$ = max installation torque moment

h = thickness of member
 h_0 = depth of drill hole depth at shoulder
 h_{ef} = effective anchorage depth
 h_{nom} = overall embedment depth

ESSVE Injection system ONE, ONE ICE for masonry

Product description
Installed condition

Annex A 1

Cartridge: ESSVE ONE or ESSVE ONE ICE

150 ml, 280 ml, 300 ml up to 333 ml and 380 ml up to 420 ml cartridge (Type: coaxial)

Sealing/Screw cap

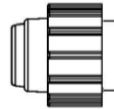

Imprint: ESSVE ONE or ESSVE ONE ICE
processing notes, charge-code, shelf life, storage
temperature, hazard-code, curing- and processing time
(depending on the temperature), optional with travel scale

235 ml, 345 ml up to 360 ml and 825 ml cartridge (Type: "side-by-side")

Sealing/Screw cap

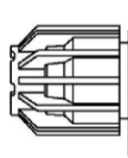

Imprint: ESSVE ONE or ESSVE ONE ICE, processing
notes, charge-code, shelf life, storage temperature,
hazard-code, curing- and processing time (depending on
the temperature), optional with travel scale

165 ml and 300 ml cartridge (Type: "foil tube")

Sealing/Screw cap

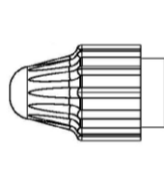

Imprint: ESSVE ONE or ESSVE ONE ICE processing notes,
charge-code, shelf life, storage temperature, hazard-code,
curing- and processing time (depending on the temperature),
optional with travel scale

Static Mixer

14W

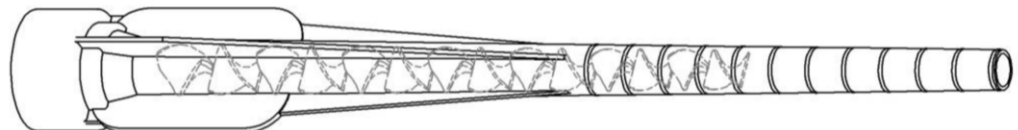

ESSVE Injection system ONE, ONE ICE for masonry

Product description
Injection system

Annex A 2

Threaded rod M8, M10, M12, M16

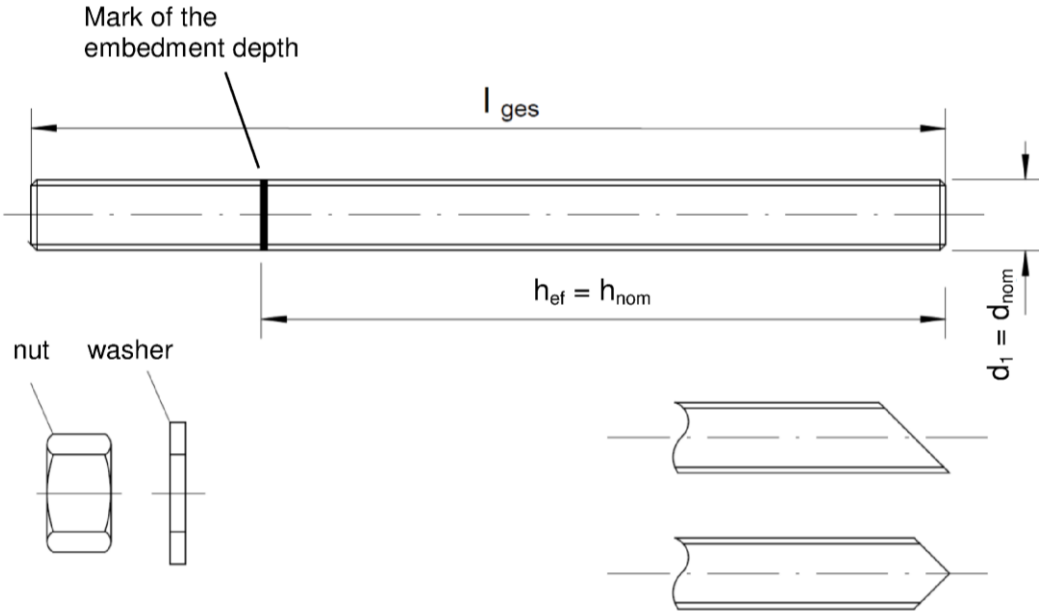



Commercial standard rod with:

- Materials, dimensions and mechanical properties acc. to Table A1
- Inspection certificate 3.1 acc. to EN 10204:2004. The document shall be stored.
- Marking of embedment depth

Internal threaded rod IG-M6, IG-M8, IG-M10

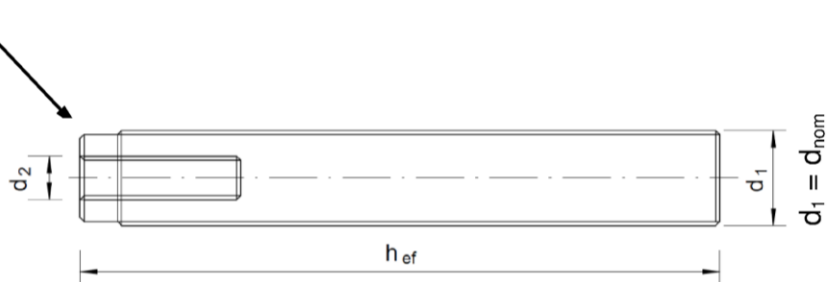
Mark the producer



Marking: e.g.  M8

ESSVE Injection system ONE, ONE ICE for masonry

Product description
Anchor rods

Annex A 3

Table A1: Materials	
Designation	Material
Steel, zinc plated $\geq 5 \mu\text{m}$ acc. to EN ISO 4042:1999 or Steel, hot-dip galvanised $\geq 40 \mu\text{m}$ acc. to EN ISO 1461:2009 and EN ISO 10684:2004+AC:2009	
Anchor rod	Steel, EN 10087:1998 or EN 10263:2001 Property class 4.6, 4.8, 5.6, 5.8, 8.8 acc. EN 1993-1-8:2005+AC:2009 $A_s > 8\%$ fracture elongation
Hexagon nut, EN ISO 4032:2012	Steel acc. EN 10087:1998 or EN 10263:2001 Property class 4 (for class 4.6, 4.8 rod) EN ISO 898-2:2012 Property class 5 (for class 5.6, 5.8 rod) EN ISO 898-2:2012 Property class 8 (for class 8.8 rod) EN ISO 898-2:2012
Washer, EN ISO 887:2006, EN ISO 7089:2000, EN ISO 7093:2000, or EN ISO 7094:2000	Steel, zinc plated or hot-dip galvanised
Internal threaded rod	Steel, zinc plated Property class 5.6, 5.8 and 8.8 EN ISO 898-1:2013
Stainless steel	
Anchor rod	Material 1.4401 / 1.4404 / 1.4571, EN 10088-1:2014, Property class 70 EN ISO 3506-1:2009 Property class 80 EN ISO 3506-1:2009
Hexagon nut, EN ISO 4032:2012	Material 1.4401 / 1.4404 / 1.4571 EN 10088-1:2014, Property class 70 (for class 70 rod) EN ISO 3506-2:2009 Property class 80 (for class 80 rod) EN ISO 3506-2:2009
Washer, EN ISO 887:2006, EN ISO 7089:2000, EN ISO 7093:2000, or EN ISO 7094:2000	Material 1.4401, 1.4404 or 1.4571, EN 10088-1:2014
Internal threaded rod	Stainless steel: 1.4401 / 1.4404 / 1.4571, EN 10088-1:2014 Property class 70 (for class 70 rod) EN ISO 3506-1:2009
High corrosion resistant steel (HCR)	
Anchor rod	Material 1.4529 / 1.4565, EN 10088-1:2014, Property class 70 EN ISO 3506-1:2009 Property class 80 EN ISO 3506-1:2009
Hexagon nut, EN ISO 4032:2012	Material 1.4529 / 1.4565, EN 10088-1:2014, Property class 70 (for class 70 rod) EN ISO 3506-2:2009 Property class 80 (for class 80 rod) EN ISO 3506-2:2009
Washer, EN ISO 887:2006, EN ISO 7089:2000, EN ISO 7093:2000, or EN ISO 7094:2000	Material 1.4529 / 1.4565, EN 10088-1:2014
Internal threaded rod	Stainless steel: 1.4529 / 1.4565, EN 10088-1:2014 Property class 70 (for class 70 rod) EN ISO 3506-1:2009
Plastic sleeve	
Perforated sleeve	Material: Polypropylene
ESSVE Injection system ONE, ONE ICE for masonry	Annex A 4
Product description Materials	

Table A2: Sleeve (Plastic)

SH 12x80
SH 16x85
SH 20x85

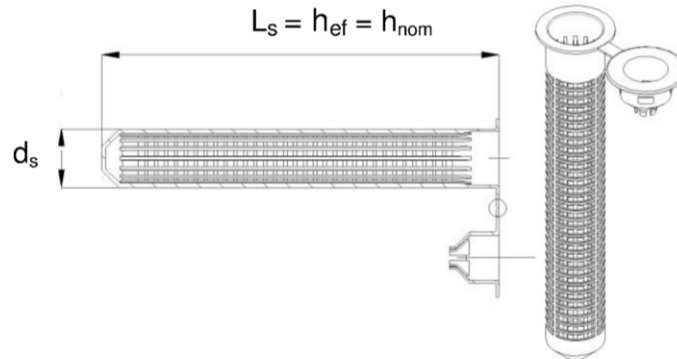

SH 16x130
SH 20x130
SH 20x200

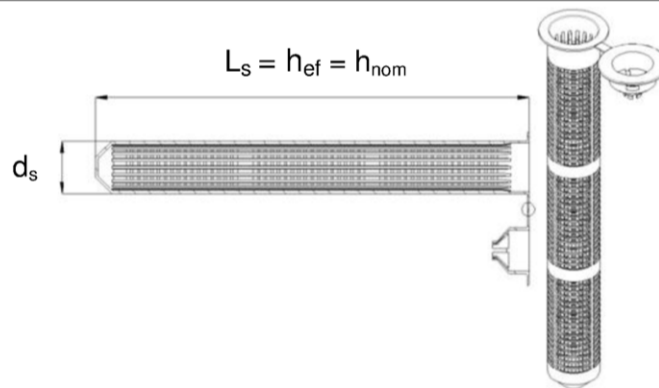

Table A3: Sizes sleeve

Sleeve		12x80	16x85	16x130	20x85	20x130	20x200
Diameter of sleeve	$d_s = d_{nom}$ [mm]	12	16	16	20	20	20
Length of sleeve	L_s [mm]	80	85	130	85	130	200
Effective anchorage depth	h_{ef} [mm]	80	85	130	85	130	200
Overall anchor embedment	h_{nom} [mm]	80	85	130	85	130	200

Table A4: Steel

Anchor rod		IG-M6	IG-M8	IG-M10	M8	M10	M12	M16
Outside diameter of anchor	$d_1 = d_{nom}$ [mm]	10 ¹⁾	12 ¹⁾	16 ¹⁾	8	10	12	16
Diameter of internal thread	d_2 [mm]	6	8	10	-	-	-	-
Thread engagement length Min/max	l_{IG} [mm]	8/20	8/20	10/25	-	-	-	-
Total length of steel element	l_{ges} [mm]	With sleeve: $h_{ef} - 5\text{mm}$ Without sleeve: h_{ef}			$h_{ef} + t_{fix} + 9,5$	$h_{ef} + t_{fix} + 11,5$	$h_{ef} + t_{fix} + 17,5$	$h_{ef} + t_{fix} + 20,0$

¹⁾ Internal threaded rod with metric external thread

ESSVE Injection system ONE, ONE ICE for masonry

Product description
Sleeves

Annex A 5

Specifications of intended use

Anchorage subject to:

- Static and quasi-static loads

Base materials:

- Autoclaved Aerated Concrete (Use category d) according to Annex B2
- Solid brick masonry (Use category b), according to Annex B2.
- Hollow brick masonry (use category c), according to Annex B2 and B3
- Mortar strength class of the masonry M2,5 at minimum according to EN 998-2:2010.
- For other bricks in solid masonry and in hollow or perforated masonry, the characteristic resistance of the anchor may be determined by job site tests according to Technical Report TR 053 under consideration of the β -factor according to Annex C1, Table C1.

Note: The characteristic resistance for solid bricks and autoclaved aerated concrete are also valid for larger brick sizes and larger compressive strength of the masonry unit.

Temperature Range:

- T_a : - 40°C to +40°C (max. short term temperature +40°C and max. long term temperature +24°C)
- T_b : - 40°C to +80°C (max. short term temperature +80°C and max. long term temperature +50°C)
- T_c : - 40°C to +120°C (max. short term temperature +120°C and max. long term temperature +72°C)

Use conditions (Environmental conditions):

- Dry and wet structure (regarding injection mortar).
- Structures subject to dry internal conditions (zinc coated steel, stainless steel or high corrosion resistant steel).
- Structures subject to external atmospheric exposure (including industrial and marine environment) and to permanently damp internal condition, if no particular aggressive conditions exist (stainless steel or high corrosion resistant steel).
- Structures subject to external atmospheric exposure and to permanently damp internal condition, if other particular aggressive conditions exist (high corrosion resistant steel).

Note: Particular aggressive conditions are e.g. permanent, alternating immersion in seawater or the splash zone of seawater, chloride atmosphere of indoor swimming pools or atmosphere with extreme chemical pollution (e.g. in desulphurization plants or road tunnels where de-icing materials are used).

Use categories in respect of installation and use:

- Category d/d: Installation and use in dry masonry
- Category w/w: Installation and use in dry or wet masonry (incl. w/d installation in wet masonry and use in dry masonry)

Design:

- Verifiable calculation notes and drawings are prepared taking account the relevant masonry in the region of the anchorage, the loads to be transmitted and their transmission to the supports of the structure. The position of the anchor is indicated on the design drawings.
- The anchorages are designed in accordance with the Technical Report TR 054, Design method A under the responsibility of an engineer experienced in anchorages and masonry work.
- $N_{Rk,p} = N_{Rk,b}$ see Annex C4 to C45; $N_{Rk,s}$ see Annex C2; $N_{Rk,pb}$ see Technical Report TR 054
- $V_{Rk,b}$ and $V_{Rk,c}$ see Annex C4 to C45; $V_{Rk,s}$ see Annex C2; $V_{Rk,pb}$ see Technical Report TR 054
- For application with sleeve with drill bit size ≤ 15 mm installed in joints not filled with mortar:
 - $N_{Rk,p,j} = 0,18 * N_{Rk,p}$ and $N_{Rk,b,j} = 0,18 * N_{Rk,b}$ ($N_{Rk,p} = N_{Rk,b}$ see Annex C4 to C45)
 - $V_{Rk,c,j} = 0,15 * V_{Rk,c}$ and $V_{Rk,b,j} = 0,15 * V_{Rk,b}$ ($V_{Rk,b}$ and $V_{Rk,c}$ see Annex C4 to C45)
- Application without sleeve installed in joints not filled with mortar is not allowed.

Installation:









- Dry or wet structures.
- Anchor Installation carried out by appropriately qualified personnel and under the supervision of the person responsible for technical matters of the site.
- Fastening screws or threaded rods (incl. nut and washer) must comply with the appropriate material and property class of the Internal threaded rod .

ESSVE Injection system ONE, ONE ICE for masonry

Intended Use
Specifications

Annex B 1

Table B1: Overview brick types and properties with corresponding fastening elements (Anchor and Sleeves)							
Brick-No.	Brick type	Picture	Brick size	Compressive strength	Bulk density	Sleeve - Anchor type	Annex
			length width height				
Autoclaved aerated concrete units according EN 771-4							
1	Autoclaved Aerated Concrete AAC6		499 240 249	6	0,6	M8/M10/M12/M16/IG-M6/IG-M8/IG-M10	C4 – C5
Calcium silicate masonry units according EN 771-2							
2	Calcium silicate solid brick KS-NF		240 115 71	10 20 27	2,0	M8/M10/M12/M16/IG-M6/IG-M8/IG-M10 SH 12x80 – M8 SH 16x85 – M8/M10/IG-M6 SH 16x130 – M8/M10/IG-M6 SH 20x85 – M12/M16/IG-M8/IG-M10 SH 20x130 – M12/M16/IG-M8/IG-M10 SH 20x200 – M12/M16/IG-M8/IG-M10	C6 – C8
3	Calcium silicate hollow brick KSL-3DF		240 175 113	8 12 14	1,4	SH 12x80 – M8 SH 16x85 – M8/M10/IG-M6 SH 16x130 – M8/M10/IG-M6 SH 20x85 – M12/M16/IG-M8/IG-M10 SH 20x130 – M12/M16/IG-M8/IG-M10 SH 20x200 – M12/M16/IG-M8/IG-M10	C9 - C11
4	Calcium silicate hollow brick KSL-12DF		498 175 238	10 12 16	1,4	SH 12x80 – M8 SH 16x85 – M8/M10/IG-M6 SH 16x130 – M8/M10/IG-M6 SH 20x85 – M12/M16/IG-M8/IG-M10 SH 20x130 – M12/M16/IG-M8/IG-M10	C12 - C14
Clay masonry units according EN 771-1							
5	Clay solid brick Mz – DF		240 115 55	10 20 28	1,6	M8/M10/M12/M16/IG-M6/IG-M8/IG-M10 SH 12x80 – M8 SH 16x85 – M8/M10/IG-M6 SH 16x130 – M8/M10/IG-M6 SH 20x85 – M12/M16/IG-M8/IG-M10 SH 20x130 – M12/M16/IG-M8/IG-M10 SH 20x200 – M12/M16/IG-M8/IG-M10	C15 - C17
6	Clay hollow brick Hlz-16DF		497 240 238	6 8 12 14	0,8	SH 12x80 – M8 SH 16x85 – M8/M10/IG-M6 SH 16x130 – M8/M10/IG-M6 SH 20x85 – M12/M16/IG-M8/IG-M10 SH 20x130 – M12/M16/IG-M8/IG-M10 SH 20x200 – M12/M16/IG-M8/IG-M10	C18 - C20
7	Clay hollow brick Porotherm Homebrick		500 200 299	4 6 10	0,7	SH 12x80 – M8 SH 16x85 – M8/M10/IG-M6 SH 16x130 – M8/M10/IG-M6 SH 20x85 – M12/M16/IG-M8/IG-M10 SH 20x130 – M12/M16/IG-M8/IG-M10	C21 - C23
ESSVE Injection system ONE, ONE ICE for masonry						Annex B 2	
Intended Use Brick types and properties with corresponding fastening elements							

Table B1: Overview brick types and properties with corresponding fastening elements (Anchor and Sleeves) (continue)							
Brick-No.	Brick type	Picture	Brick size	Compressive strength	Bulk density	Sleeve - Anchor type	Annex
			length width height [mm]				
Clay masonry units according EN 771-1							
8	Clay hollow brick BGV Thermo		500 200 314	4 6 10	0,6	SH 12x80 – M8 SH 16x85 – M8/M10/IG-M6 SH 16x130 – M8/M10/IG-M6 SH 20x85 – M12/M16/IG-M8/IG-M10 SH 20x130 – M12/M16/IG-M8/IG-M10	C24 - C26
9	Clay hollow brick Calibric R+		500 200 314	6 9 12	0,6	SH 12x80 – M8 SH 16x85 – M8/M10/IG-M6 SH 16x130 – M8/M10/IG-M6 SH 20x85 – M12/M16/IG-M8/IG-M10 SH 20x130 – M12/M16/IG-M8/IG-M10	C27- C29
10	Clay hollow brick Urbanbric		560 200 274	6 9 12	0,7	SH 12x80 – M8 SH 16x85 – M8/M10/IG-M6 SH 16x130 – M8/M10/IG-M6 SH 20x85 – M12/M16/IG-M8/IG-M10 SH 20x130 – M12/M16/IG-M8/IG-M10	C30 - C32
11	Clay hollow brick Brique creuse C40		500 200 200	4 8 12	0,7	SH 12x80 – M8 SH 16x85 – M8/M10/IG-M6 SH 16x130 – M8/M10/IG-M6 SH 20x85 – M12/M16/IG-M8/IG-M10 SH 20x130 – M12/M16/IG-M8/IG-M10	C33 - C35
12	Clay hollow brick Blocchi Leggeri		250 120 250	4 6 8 12	0,6	SH 12x80 – M8 SH 16x85 – M8/M10/IG-M6 SH 16x130 – M8/M10/IG-M6 SH 20x85 – M12/M16/IG-M8/IG-M10 SH 20x130 – M12/M16/IG-M8/IG-M10 SH 20x200 – M12/M16/IG-M8/IG-M10	C36 - C38
13	Clay hollow brick Doppio Uni		250 120 120	10 16 20 28	0,9	SH 12x80 – M8 SH 16x85 – M8/M10/IG-M6 SH 16x130 – M8/M10/IG-M6 SH 20x85 – M12/M16/IG-M8/IG-M10 SH 20x130 – M12/M16/IG-M8/IG-M10 SH 20x200 – M12/M16/IG-M8/IG-M10	C39 - C41
Light weight concrete according EN 771-3							
14	Hollow light weight concrete Bloc creux B40		494 200 190	4	0,8	SH 12x80 – M8 SH 16x85 – M8/M10/IG-M6 SH 16x130 – M8/M10/IG-M6 SH 20x85 – M12/M16/IG-M8/IG-M10 SH 20x130 – M12/M16/IG-M8/IG-M10	C42 - C43
15	Solid light weight concrete		300 123 248	2	0,6	M8/M10/M12/M16/IG-M6/IG-M8/IG-M10 SH 12x80 – M8 SH 16x85 – M8/M10/IG-M6 SH 16x130 – M8/M10/IG-M6 SH 20x85 – M12/M16/IG-M8/IG-M10 SH 20x130 – M12/M16/IG-M8/IG-M10 SH 20x200 – M12/M16/IG-M8/IG-M10	C44 - C45
ESSVE Injection system ONE, ONE ICE for masonry						Annex B 3	
Intended Use Brick types and properties with corresponding fastening elements							

Installation: Steel Brush RBT

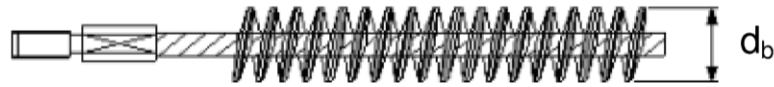

Table B2: Installation parameters in autoclaved aerated concrete AAC and solid masonry (without sleeve)

Anchor size			M8	M10	IG-M6	M12	IG-M8	M16	IG-M10
Nominal drill hole diameter	d_0	[mm]	10	12		14		18	
Drill hole depth	h_0	[mm]	80	90		100		100	
Effective anchorage depth	h_{ef}	[mm]	80	90		100		100	
Minimum wall thickness	h_{min}	[mm]	$h_{ef} + 30$						
Diameter of clearance hole in the fixture	$d_f \leq$	[mm]	9	12	7	14	9	18	12
Diameter of steel brush			RBT10	RBT12		RBT14		RBT18	
	d_b	[mm]	12	14		16		20	
Minimum diameter of steel brush	$d_{b,min}$	[mm]	10,5	12,5		14,5		18,5	
Max installation torque moment	$T_{inst,max}$	[Nm]	2 (14 for Mz DF)						

Table B3: Installation parameters in solid and hollow masonry (with sleeve)

Anchor size			M8	M8 / M10 / IG-M6	M12 / M16 / IG-M8 / IG-M10			
Sleeve			12x80	16x85	16x130	20x85	20x130	20x200
Nominal drill hole diameter	d_0	[mm]	12	16	16	20	20	20
Drill hole depth	h_0	[mm]	85	90	135	90	135	205
Effective anchorage depth	h_{ef}	[mm]	80	85	130	85	130	200
Minimum wall thickness	h_{min}	[mm]	115	115	175	115	175	240
Diameter of clearance hole in the fixture	$d_f \leq$	[mm]	9	7 (IG-M6) / 9 (M8) / 12 (M10)		9 (IG-M8) / 12 (IG-M10) / 14 (M12) / 18 (M16)		
Diameter of steel brush			RBT12	RBT16		RBT20		
	d_b	[mm]	14	18		22		
Minimum diameter of steel brush	$d_{b,min}$	[mm]	12,5	16,5		20,5		
Max installation torque moment	$T_{inst,max}$	[Nm]	2					

ESSVE Injection system ONE, ONE ICE for masonry

Intended Use

Installation parameters and cleaning brush

Annex B 4

**Table B4: Maximum working time and minimum curing time
ESSVE ONE**

Temperature in the base material T	Temperature of cartridge	Gelling- / working time	Minimum curing time in dry base material ¹⁾
0 °C to + 4 °C	+5°C to +40°C	45 min	7 h
+ 5 °C to + 9 °C		25 min	2 h
+ 10 °C to + 19 °C		15 min	80 min
+ 20 °C to + 29 °C		6 min	45 min
+ 30 °C to + 34 °C		4 min	25 min
+ 35 °C to + 39 °C		2 min	20 min
+ 40°C		1,5 min	15 min

¹⁾ In wet base material the curing time **must** be doubled

**Table B5: Maximum working time and minimum curing time
ESSVE ONE ICE**

Temperature in the base material T	Temperature of cartridge	Gelling- / working time	Minimum curing time in dry base material ¹⁾
0 °C to + 4 °C	0°C to +10°C	10 min	2,5 h
+ 5 °C to + 9 °C		6 min	80 min
+ 10°C		6 min	60 min

¹⁾ In wet base material the curing time **must** be doubled

ESSVE Injection system ONE, ONE ICE for masonry

Intended Use
Gelling and Curing times

Annex B 5

Installation Instructions

Preparation of cartridge

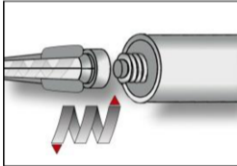

1. Remove the cap and attach the supplied static-mixing nozzle to the cartridge and load the cartridge into the correct dispensing tool. In case of a foil tube cartridge, cut off the clip before use. For every working interruption longer than the recommended working time (Annex B 5) as well as for new cartridges, a new static-mixer shall be used.

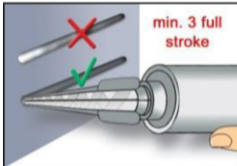

2. Initial adhesive is not suitable for fixing the anchor. Prior to dispensing into the anchor hole, squeeze out separately a minimum of three full strokes, for foil tube cartridges six full strokes and discard non-uniformly mixed adhesive components until the mortar shows a consistent grey colour.

Installation in solid masonry (without sleeve)

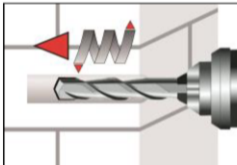

3. Holes to be drilled perpendicular to the surface of the base material by using a hard-metal tipped hammer drill bit. Drill a hole, with drilling method according to Annex C4-C45, into the base material, with nominal drill hole diameter and bore hole depth according to the size and embedment depth required by the selected anchor. In case of aborted drill hole the drill hole shall be filled with mortar.

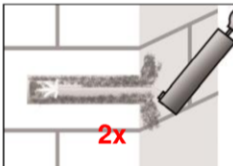
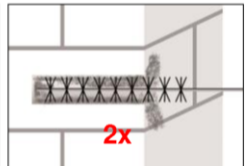
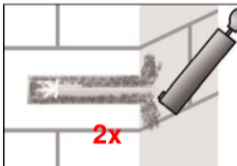

4. Blow out from the bottom of the bore hole two times. Attach the appropriate sized brush ($> d_{b,min}$ Table B2 or B3) to a drilling machine or a battery screwdriver, brush the hole clean two times, and finally blow out the hole again two times.

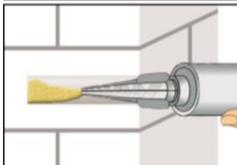

5. Starting from the bottom or back of the cleaned anchor hole, fill the hole up to min two-thirds with adhesive. Slowly withdraw the static mixing nozzle will avoid creating air pockets. Observe the gel-/ working times given in Annex B 5.

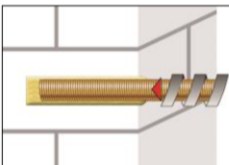
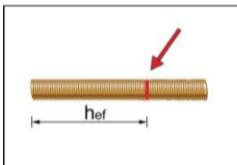

6. The position of the embedment depth shall be marked on the threaded rod. Push the threaded rod into the anchor hole while turning slightly to ensure positive distribution of the adhesive until the embedment depth is reached. The anchor shall be free of dirt, grease, oil or other foreign material.

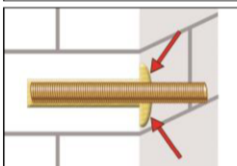

7. Be sure that the annular gap is fully filled with mortar. If no excess mortar is visible at the top of the hole, the application has to be renewed.

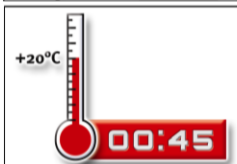

8. Allow the adhesive to cure to the specified curing time prior to applying any load or torque. Do not move or load the anchor until it is fully cured (attend Annex B 5).

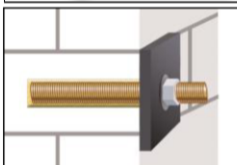

9. After full curing, the fixture can be installed with up to the max. installation torque (see Annex B4) by using a calibrated torque wrench.

ESSVE Injection system ONE, ONE ICE for masonry

Intended Use

Installation instructions Solid masonry and Autoclaved Aerated Concrete

Annex B 6

Installation in solid and hollow masonry (with sleeve)

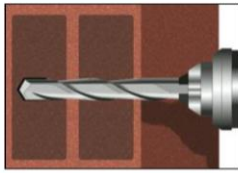

3. Holes to be drilled perpendicular to the surface of the base material by using a hard-metal tipped hammer drill bit. Drill a hole, with drill method according to Annex C4 – C45, into the base material, with nominal drill hole diameter and bore hole depth according to the size and embedment depth required by the selected anchor.

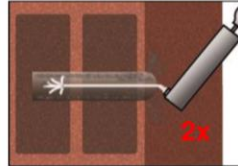
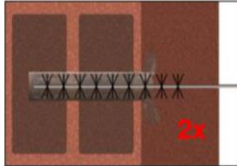
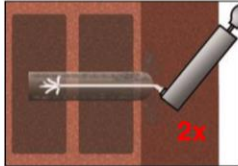

4. Blow out from the bottom of the bore hole two times. Attach the appropriate sized brush (> $d_{b,min}$ Table B3) to a drilling machine or a battery screwdriver, brush the hole clean two times, and finally blow out the hole again two times.

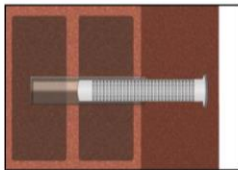

5. Insert the perforated sleeve flush with the surface of the masonry or plaster. Only use sleeves that have the right length. Never cut the sleeve.

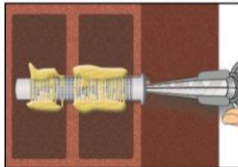

6. Starting from the bottom or back fill the sleeve with adhesive. For embedment depth equal to or larger than 130 mm an extension nozzle shall be used. For quantity of mortar attend cartridges label installation instructions. Observe the gel-/ working times given in Annex B 5.

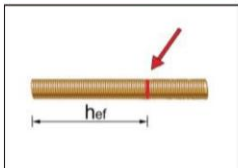

7. The position of the embedment depth shall be marked on the threaded rod. Push the threaded rod into the anchor hole while turning slightly to ensure positive distribution of the adhesive until the embedment depth is reached. The anchor shall be free of dirt, grease, oil or other foreign material.

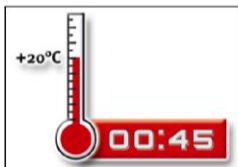

8. Allow the adhesive to cure to the specified curing time prior to applying any load or torque. Do not move or load the anchor until it is fully cured (attend Annex B 5).

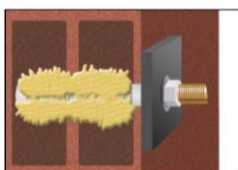

9. After full curing, the fixture can be installed with up to the max. installation torque (see Annex B4) by using a calibrated torque wrench.

ESSVE Injection system ONE, ONE ICE for masonry

Intended Use

Installation instructions hollow brick

Annex B 7

Table C1: β -factor for job-site testing under tension loading

Brick-No. and abbreviation	Installation & Use category	β -factor					
		$T_a: 40^\circ\text{C} / 24^\circ\text{C}$		$T_b: 80^\circ\text{C} / 50^\circ\text{C}$		$T_c: 120^\circ\text{C} / 72^\circ\text{C}$	
		d/d	w/d w/w	d/d	w/d w/w	d/d	w/d w/w
1 AAC6	For all sizes	0,95	0,86	0,81	0,73	0,81	0,73
2 KS-NF	$d_0 \leq 14$ mm	0,93	0,80	0,87	0,74	0,65	0,56
	$d_0 \geq 16$ mm	0,93	0,93	0,87	0,87	0,65	0,65
3 KSL-3DF	$d_0 \leq 12$ mm	0,93	0,80	0,87	0,74	0,65	0,56
	$d_0 \geq 16$ mm	0,93	0,93	0,87	0,87	0,65	0,65
4 KSL-12DF	$d_0 \leq 12$ mm	0,93	0,80	0,87	0,74	0,65	0,56
	$d_0 \geq 16$ mm	0,93	0,93	0,87	0,87	0,65	0,65
5 MZ-DF	For all sizes	0,86	0,86	0,86	0,86	0,73	0,73
6 Hz-16DF							
7 Porotherm Homebric							
8 BGV-Thermo							
9 Calibric R+							
10 Urbanbric							
11 Brique creuse C40							
12 Blocchi Leggeri							
13 Doppio Uni							
14 Bloc creux B40							
15 Solid light weight concrete	$d_0 \leq 12$ mm	0,93	0,80	0,87	0,74	0,65	0,56
	$d_0 \geq 16$ mm	0,93	0,93	0,87	0,87	0,65	0,65

ESSVE Injection system ONE, ONE ICE for masonry

Performances

β -factors for job site testing under tension load

Annex C 1

Table C2: Characteristic steel resistance									
Size			IG-M6	IG-M8	IG-M10	M8	M10	M12	M16
Characteristic tension resistance									
steel, property class 4.6	$N_{Rk,s}$	[kN]	-	-	-	15	23	34	63
	γ_{Ms}	[-]	2,0						
steel, property class 4.8	$N_{Rk,s}$	[kN]	-	-	-	15	23	34	63
	γ_{Ms}	[-]	1,5						
steel, property class 5.6	$N_{Rk,s}$	[kN]	10	18	29	18	29	42	79
	γ_{Ms}	[-]	2,0						
steel, property class 5.8	$N_{Rk,s}$	[kN]	10	17	29	18	29	42	79
	γ_{Ms}	[-]	1,5						
steel, property class 8.8	$N_{Rk,s}$	[kN]	16	27	46	29	46	67	126
	γ_{Ms}	[-]	1,5						
Stainless steel A4 / HCR, property class 70	$N_{Rk,s}$	[kN]	14	26	41	26	41	59	110
	γ_{Ms}	[-]	1,87						
Stainless steel A4 / HCR, property class 80	$N_{Rk,s}$	[kN]	16	29	46	29	46	67	126
	γ_{Ms}	[-]	1,6						
Characteristic shear resistance									
steel, property class 4.6	$V_{Rk,s}$	[kN]	-	-	-	7	12	17	31
	γ_{Ms}	[-]	1,67						
steel, property class 4.8	$V_{Rk,s}$	[kN]	-	-	-	7	12	17	31
	γ_{Ms}	[-]	1,25						
steel, property class 5.6	$V_{Rk,s}$	[kN]	5	9	15	9	15	21	39
	γ_{Ms}	[-]	1,67						
steel, property class 5.8	$V_{Rk,s}$	[kN]	5	9	15	9	15	21	39
	γ_{Ms}	[-]	1,25						
steel, property class 8.8	$V_{Rk,s}$	[kN]	8	14	23	15	23	34	63
	γ_{Ms}	[-]	1,25						
Stainless steel A4 / HCR, property class 70	$V_{Rk,s}$	[kN]	7	13	20	13	20	30	55
	γ_{Ms}	[-]	1,56						
Stainless steel A4 / HCR, property class 80	$V_{Rk,s}$	[kN]	8	15	23	15	23	34	63
	γ_{Ms}	[-]	1,33						
Characteristic bending moment									
steel, property class 4.6	$M_{Rk,s}$	[Nm]	-	-	-	15	30	52	133
	γ_{Ms}	[-]	1,67						
steel, property class 4.8	$M_{Rk,s}$	[Nm]	-	-	-	15	30	52	133
	γ_{Ms}	[-]	1,25						
steel, property class 5.6	$M_{Rk,s}$	[Nm]	8	19	37	19	37	66	167
	γ_{Ms}	[-]	1,67						
steel, property class 5.8	$M_{Rk,s}$	[Nm]	8	19	37	19	37	66	167
	γ_{Ms}	[-]	1,25						
steel, property class 8.8	$M_{Rk,s}$	[Nm]	12	30	60	30	60	105	266
	γ_{Ms}	[-]	1,25						
Stainless steel A4 / HCR, property class 70	$M_{Rk,s}$	[Nm]	11	26	52	26	52	92	233
	γ_{Ms}	[-]	1,56						
Stainless steel A4 / HCR, property class 80	$M_{Rk,s}$	[Nm]	12	30	60	30	60	105	266
	γ_{Ms}	[-]	1,33						
ESSVE Injection system ONE, ONE ICE for masonry						Annex C 2			
Performances Characteristic resistance under tension and shear load – steel failure									

Spacing and edge distances

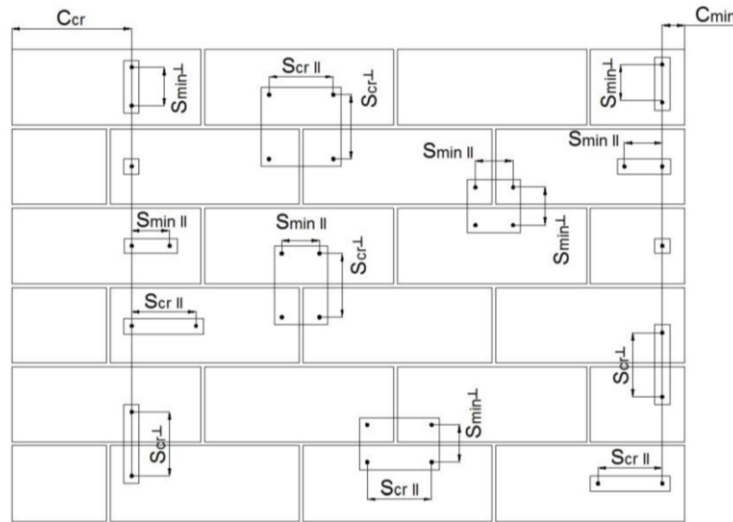

- C_{cr} = Characteristic edge distance
- C_{min} = Minimum Edge distance
- S_{cr} = Characteristic spacing
- S_{min} = Minimum spacing
- $S_{cr,II}; (S_{min,II})$ = Characteristic (minimum) spacing for anchors placed parallel to bed joint
- $S_{cr,\perp}; (S_{min,\perp})$ = Characteristic (minimum) spacing for anchors placed perpendicular to bed joint

Load direction / Anchor position	Tension load	Shear load parallel to free edge	Shear load perpendicular to free edge
Anchors places parallel to bed joint $s_{cr,II}; (s_{min,II})$			
Anchors places perpendicular to bed joint $s_{cr,\perp}; (s_{min,\perp})$			

- $\alpha_{g,N,II}$ = Group factor in case of tension load for anchors placed parallel to the bed joint
- $\alpha_{g,V,II}$ = Group factor in case of shear load for anchors placed parallel to the bed joint
- $\alpha_{g,N,\perp}$ = Group factor in case of tension load for anchors placed perpendicular to the bed joint
- $\alpha_{g,V,\perp}$ = Group factor in case of shear load for anchors placed perpendicular to the bed joint

Group of two anchors: $N_{RK}^g = \alpha_{g,N} * N_{RK}$ and $V_{RK}^g = \alpha_{g,V} * V_{RK}$

Group of four anchors: $N_{RK}^g = \alpha_{g,N,II} * \alpha_{g,N,\perp} * N_{RK}$ and $V_{RK}^g = \alpha_{g,V,II} * \alpha_{g,V,\perp} * V_{RK}$

(N_{RK} : $N_{RK,b}$ or $N_{RK,b,j}$ for c_{cr})
 (V_{RK} : $V_{RK,c}$; $V_{RK,c,j}$; $V_{RK,b}$ or $V_{RK,b,j}$ for c_{cr})
 (with the relevant α_g)

ESSVE Injection system ONE, ONE ICE for masonry

Performances

Edge distance and anchor spacing

Annex C 3

Brick type: Autoclaved Aerated Concrete – AAC6

Table C3: Description of the brick

Brick type	Autoclaved Aerated Concrete AAC6	
Bulk density ρ [kg/dm ³]	0,6	
Compressive strength $f_b \geq$ [N/mm ²]	6	
Code	EN 771-4	
Producer (country code)	e.g. Porit (DE)	
Brick dimensions [mm]	499 x 240 x 249	
Drilling method	Rotary	

Table C4: Installation parameter

Anchor size		[-]	M8	M10/IG-M6	M12/IG-M8	M16/IG-M10
Effective anchorage depth		[mm]	80	90	100	100
Edge distance	C_{cr}	[mm]	1,5* h_{ef}			
Minimum edge distance	$C_{min,N}$	[mm]	75			
	$C_{min,V,II}$ ($C_{min,v,\perp}$) ¹⁾	[mm]	75 (1,5* h_{ef})			
Spacing	S_{cr}	[mm]	3* h_{ef}			
Minimum spacing	S_{min}	[mm]	100			

¹⁾ $C_{min,v,II}$ for shear loading parallel to the free edge; $C_{min,v,\perp}$ for shear loading perpendicular the free edge

Table C5: Group factor for anchor group in case of tension loading

Configuration		with $c \geq$	with $s \geq$			
II: anchors placed parallel to horizontal joint		125 (M8:120)	100	$\alpha_{g,N,II}$	[-]	1,8
		1,5* h_{ef}	3* h_{ef}			2,0
⊥: anchors placed perpendicular to horizontal joint		75	100	$\alpha_{g,N,\perp}$		1,4
		1,5* h_{ef}	3* h_{ef}			2,0

Table C6: Group factor for anchor group in case of shear loading parallel to free edge

Configuration		with $c \geq$	with $s \geq$			
II: anchors placed parallel to horizontal joint		75	100	$\alpha_{g,V,II}$	[-]	1,2
		1,5* h_{ef}	3* h_{ef}			2,0
⊥: anchors placed perpendicular to horizontal joint		1,5* h_{ef}	3* h_{ef}	$\alpha_{g,V,\perp}$		2,0

ESSVE Injection system ONE, ONE ICE for masonry

Performances Autoclaved Aerated Concrete - AAC6

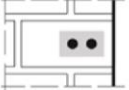
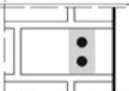
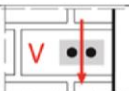
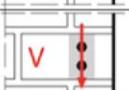
Description of the brick
Installation parameters

Annex C 4

Brick type: Autoclaved Aerated Concrete – AAC6

Table C7: Group factor for anchor group in case of shear loading perpendicular to free edge

Configuration		with $c \geq$	with $s \geq$			
II: anchors placed parallel to horizontal joint		$1,5 \cdot h_{ef}$	$3,0 \cdot h_{ef}$	$\alpha_{g,V,II}$	[-]	2,0
I: anchors placed perpendicular to horizontal joint		$1,5 \cdot h_{ef}$	$3,0 \cdot h_{ef}$	$\alpha_{g,V,I}$		2,0

Table C8: Characteristic values of resistance under tension and shear loads

Anchor size	Effective anchorage depth	Characteristic resistance						
		Use category						
		d/d			w/w w/d			d/d w/d w/w
		40°C/24°C	80°C/50°C	120°C/72°C	40°C/24°C	80°C/50°C	120°C/72°C	For all temperature range
	h_{ef}	$N_{Rk,b} = N_{Rk,p}^{1)}$			$N_{Rk,b} = N_{Rk,p}^{1)}$			$V_{Rk,b}^{2)3)}$
	[mm]	[kN]						
Compressive strength $f_b \geq 6 \text{ N/mm}^2$								
M8	80	2,5 (2,0)	2,5 (1,5)	2,0 (1,2)	2,5 (1,5)	2,0 (1,5)	1,5 (1,2)	6,0
M10/IG-M6	90	4,0 (2,5)	3,0 (2,0)	2,5 (1,5)	3,5 (2,5)	3,0 (2,0)	2,5 (1,5)	10,0
M12/IG-M8	100	5,0 (3,5)	4,0 (3,0)	3,0 (2,5)	4,5 (3,0)	3,5 (2,5)	3,0 (2,5)	10,0
M16/IG-M10	100	6,5 (4,5)	5,5 (3,5)	4,0 (3,0)	5,5 (4,0)	5,0 (3,5)	4,0 (3,0)	10,0

- 1) Values are valid for c_{cr} , values in brackets are valid for single anchors with c_{min}
 2) For calculation of $V_{Rk,c}$ see ETAG029, Annex C;
 3) The values are valid for steel 5.6 or greater. For steel 4.6 and 4.8 multiply $V_{Rk,b}$ by 0,8

Table C9: Displacements

Anchor size	h_{ef}	N	δ_N / N	δ_{N0}	$\delta_{N\infty}$	V	δ_{V0}	$\delta_{V\infty}$
	[mm]	[kN]	[mm/kN]	[mm]	[mm]	[kN]	[mm]	[mm]
M8	80	0,9	0,18	0,16	0,32	1,3	0,8	1,20
M10/IG-M6	90	1,4		0,26	0,51	1,8	1,2	1,80
M12/IG-M8	100	1,8	0,08	0,14	0,29	2,1	1,4	2,10
M16/IG-M10	100	2,3		0,19	0,37	2,3	1,5	2,25

ESSVE Injection system ONE, ONE ICE for masonry

Performances Autoclaved Aerated Concrete – AAC6

Installation parameters (continue)

Characteristic values of resistance under tension and shear load / Displacements

Annex C 5

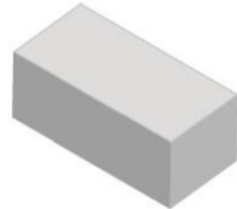

Brick type: Calcium silicate solid brick KS-NF

Table C10: Description of the brick

Brick type	Calcium silicate solid brick KS-NF
Bulk density ρ [kg/dm ³]	2,0
Compressive strength $f_b \geq$ [N/mm ²]	10, 20 or 27
Code	EN 771-2
Producer (country code)	e.g. Wemding (DE)
Brick dimensions [mm]	240 x 115 x 71
Drilling method	Hammer

Table C11: Installation parameter

Anchor size		[-]	All sizes
Edge distance	c_{cr}	[mm]	$1,5 \cdot h_{ef}$
Minimum edge distance	c_{min}	[mm]	60
Spacing	s_{cr}	[mm]	$3 \cdot h_{ef}$
Minimum spacing	s_{min}	[mm]	120

Table C12: Group factor for anchor group in case of tension loading

Configuration		with $c \geq$	with $s \geq$			
II: anchors placed parallel to horizontal joint		60	120	$\alpha_{g,N,II}$	[-]	1,0
		140	120			1,5
		$1,5 \cdot h_{ef}$	$3 \cdot h_{ef}$			2,0
⊥: anchors placed perpendicular to horizontal joint		60	120	$\alpha_{g,N,\perp}$	[-]	0,5
		$1,5 \cdot h_{ef}$	120			1,0
		$1,5 \cdot h_{ef}$	$3 \cdot h_{ef}$			2,0

Table C13: Group factor for anchor group in case of shear loading parallel to free edge

Configuration		with $c \geq$	with $s \geq$			
II: anchors placed parallel to horizontal joint		60	120	$\alpha_{g,V,II}$	[-]	1,0
		115	120			1,7
		$1,5 \cdot h_{ef}$	$3 \cdot h_{ef}$			2,0
⊥: anchors placed perpendicular to horizontal joint		60	120	$\alpha_{g,V,\perp}$	[-]	1,0
		$1,5 \cdot h_{ef}$	120			1,0
		$1,5 \cdot h_{ef}$	$3 \cdot h_{ef}$			2,0

Table C14: Group factor for anchor group in case of shear loading perpendicular to free edge

Configuration		with $c \geq$	with $s \geq$			
II: anchors placed parallel to horizontal joint		60	120	$\alpha_{g,V,II}$	[-]	1,0
		$1,5 \cdot h_{ef}$	$3 \cdot h_{ef}$			2,0
⊥: anchors placed perpendicular to horizontal joint		60	120	$\alpha_{g,V,\perp}$	[-]	1,0
		$1,5 \cdot h_{ef}$	$3 \cdot h_{ef}$			2,0

ESSVE Injection system ONE, ONE ICE for masonry

Performances calcium solid brick KS-NF
Installation parameters

Annex C 6

Brick type: Calcium silicate solid brick KS-NF

Table C15: Characteristic values of resistance under tension and shear loads

Anchor size	Sleeve	Effective anchorage depth h_{ef} [mm]	Characteristic resistance						
			Use category						
			d/d			w/d w/w			d/d w/d w/w
			40°C/24°C	80°C/50°C	120°C/72°C	40°C/24°C	80°C/50°C	120°C/72°C	For All temperature range
h_{ef}	$N_{Rk,b} = N_{Rk,p}^{1)}$			$N_{Rk,b} = N_{Rk,p}^{1)}$			$V_{Rk,b}^{2)3)}$		
[mm]	[kN]								
Compressive strength $f_b \geq 10 \text{ N/mm}^2$									
M8	-	80	4,5 (2,0)	4,5 (2,0)	3,0 (1,5)	3,5 (1,5)	3,5 (1,5)	2,5 (1,2)	2,5 (1,5)
M10 / IG-M6	-	90	4,5 (2,0)	4,5 (2,0)	3,0 (1,5)	3,5 (1,5)	3,5 (1,5)	2,5 (1,2)	3,0 (2,0)
M12 / IG-M8	-	100	4,5 (2,0)	4,5 (2,0)	3,0 (1,5)	3,5 (1,5)	3,5 (1,5)	2,5 (1,2)	2,5 (1,5)
M16 / IG-M10	-	100	3,5 (1,5)	3,5 (1,5)	2,5 (1,2)	3,0 (1,5)	3,5 (1,5)	2,0 (0,9)	2,5 (1,5)
M8	12x80	80	3,5 (1,5)	3,5 (1,5)	2,5 (1,2)	3,5 (1,5)	3,0 (1,5)	2,5 (1,2)	2,5 (1,5)
M8 / M10 / IG-M6	16x85	85	3,5 (1,5)	3,0 (1,5)	2,0 (0,9)	3,5 (1,5)	3,0 (1,5)	2,5 (1,2)	2,5 (1,5)
	16x130	130	3,5 (1,5)	3,0 (1,5)	2,0 (0,9)	3,5 (1,5)	3,0 (1,5)	2,5 (1,2)	2,5 (1,5)
M12 / M16 / IG-M8 / IG-M10	20x85	85	3,0 (1,5)	2,5 (1,2)	2,0 (0,9)	3,0 (1,5)	2,5 (1,2)	2,0 (0,9)	2,5 (1,5)
	20x130	130	3,0 (1,5)	2,5 (1,2)	2,0 (0,9)	3,0 (1,5)	2,5 (1,2)	2,0 (0,9)	2,5 (1,5)
	20x200	200	3,0 (1,5)	2,5 (1,2)	2,0 (0,9)	3,0 (1,5)	2,5 (1,2)	2,0 (0,9)	2,5 (1,5)
Compressive strength $f_b \geq 20 \text{ N/mm}^2$									
M8	-	80	6,0 (3,0)	5,5 (2,5)	4,0 (2,0)	5,0 (2,5)	5,0 (2,5)	3,5 (1,5)	4,0 (2,5)
M10 / IG-M6	-	90	6,0 (3,0)	5,5 (2,5)	4,0 (2,0)	5,0 (2,5)	5,0 (2,5)	3,5 (1,5)	4,5 (2,5)
M12 / IG-M8	-	100	6,0 (3,0)	5,5 (2,5)	4,0 (2,0)	5,0 (2,5)	5,0 (2,5)	3,5 (1,5)	4,0 (2,5)
M16 / IG-M10	-	100	5,0 (2,5)	5,0 (2,5)	3,5 (1,5)	5,0 (2,5)	5,0 (2,5)	3,5 (1,5)	4,0 (2,5)
M8	12x80	80	5,5 (2,5)	5,0 (2,5)	3,5 (1,5)	4,5 (2,0)	4,5 (2,0)	3,0 (1,5)	4,0 (2,5)
M8 / M10 / IG-M6	16x85	85	5,0 (2,5)	4,5 (2,0)	3,5 (1,5)	5,0 (2,5)	4,5 (2,0)	3,5 (1,5)	4,0 (2,5)
	16x130	130	5,0 (2,5)	4,5 (2,0)	3,5 (1,5)	5,0 (2,5)	4,5 (2,0)	3,5 (1,5)	4,0 (2,5)
M12 / M16 / IG-M8 / IG-M10	20x85	85	4,0 (2,0)	4,0 (2,0)	3,0 (1,5)	4,0 (2,0)	4,0 (2,0)	3,0 (1,5)	4,0 (2,5)
	20x130	130	4,0 (2,0)	4,0 (2,0)	3,0 (1,5)	4,0 (2,0)	4,0 (2,0)	3,0 (1,5)	4,0 (2,5)
	20x200	200	4,0 (2,0)	4,0 (2,0)	3,0 (1,5)	4,0 (2,0)	4,0 (2,0)	3,0 (1,5)	4,0 (2,5)
¹⁾ Values are valid for c_{cr} , values in brackets are valid for single anchors with c_{min} ²⁾ For c_{cr} calculation of $V_{Rk,c}$ see Technical Report TR 054; values in brackets $V_{Rk,b} = V_{Rk,c}$ for single anchors with c_{min} ³⁾ The values are valid for steel 5.6 or greater. For steel 4.6 and 4.8 multiply $V_{Rk,b}$ by 0,8									
ESSVE Injection system ONE, ONE ICE for masonry								Annex C 7	
Performances calcium solid brick KS-NF									
Characteristic values of resistance under tension and shear load									

Brick type: Calcium silicate solid brick KS-NF									
Table C16: Characteristic values of resistance under tension and shear loads (continue)									
Anchor size	Sleeve	Effective anchorage depth h_{ef} [mm]	Characteristic resistance						
			Use category						
			d/d			w/d w/w			d/d w/d w/w
			40°C/24°C	80°C/50°C	120°C/72°C	40°C/24°C	80°C/50°C	120°C/72°C	For All temperature range
h_{ef}	$N_{Rk,b} = N_{Rk,p}^{1)}$			$N_{Rk,b} = N_{Rk,p}^{1)}$			$V_{Rk,b}^{2,3)}$		
[mm]	[kN]								
Compressive strength $f_b \geq 27 \text{ N/mm}^2$									
M8	-	80	7,0 (3,5)	6,5 (3,0)	5,0 (2,5)	6,0 (3,0)	5,5 (2,5)	4,0 (2,0)	4,5 (2,5)
M10 / IG-M6	-	90	7,0 (3,5)	6,5 (3,0)	5,0 (2,5)	6,0 (3,0)	5,5 (2,5)	4,0 (2,0)	5,5 (3,0)
M12 / IG-M8	-	100	7,0 (3,5)	6,5 (3,0)	5,0 (2,5)	6,0 (3,0)	5,5 (2,5)	4,0 (2,0)	4,5 (2,5)
M16 / IG-M10	-	100	6,0 (3,0)	5,5 (2,5)	4,5 (2,0)	6,0 (3,0)	5,5 (2,5)	4,0 (2,0)	4,5 (2,5)
M8	12x80	80	6,5 (3,0)	6,0 (3,0)	4,5 (2,0)	5,5 (2,5)	5,0 (2,5)	3,5 (1,5)	4,5 (2,5)
M8 / M10 / IG-M6	16x85	85	5,5 (2,5)	5,0 (2,5)	4,0 (2,0)	5,5 (2,5)	5,0 (2,5)	4,0 (2,0)	4,5 (2,5)
	16x130	130	5,5 (2,5)	5,0 (2,5)	4,0 (2,0)	5,5 (2,5)	5,0 (2,5)	4,0 (2,0)	4,5 (2,5)
M12 / M16 / IG-M8 / IG-M10	20x85	85	5,0 (2,5)	4,5 (2,0)	3,5 (1,5)	5,0 (2,5)	4,5 (2,0)	3,5 (1,5)	4,5 (2,5)
	20x130	130	5,0 (2,5)	4,5 (2,0)	3,5 (1,5)	5,0 (2,5)	4,5 (2,0)	3,5 (1,5)	4,5 (2,5)
	20x200	200	5,0 (2,5)	4,5 (2,0)	3,5 (1,5)	5,0 (2,5)	4,5 (2,0)	3,5 (1,5)	4,5 (2,5)
¹⁾ Values are valid for c_{cr} , values in brackets are valid for single anchors with c_{min} ²⁾ For c_{cr} calculation of $V_{Rk,c}$ see Technical Report TR 054; values in brackets $V_{Rk,b} = V_{Rk,c}$ for single anchors with c_{min} ³⁾ The values are valid for steel 5.6 or greater. For steel 4.6 and 4.8 multiply $V_{Rk,b}$ by 0,8									
Table C17: Displacements									
Anchor size	Sleeve	Effective anchorage depth h_{ef}	N	δ_N / N	δ_{N0}	$\delta_{N\infty}$	V	δ_{V0}	$\delta_{V\infty}$
M8	-	80	2,0	0,15	0,30	0,60	1,7	0,90	1,35
M10 / IG-M6	-	90							
M12 / IG-M8	-	100							
M16 / IG-M10	-	100	1,7		0,26	0,51			
M8	12x80	80	1,4		0,21	0,43	1,7	0,90	1,35
M8 / M10 / IG-M6	16x85	85							
		16x130	130						
M12 / M16 / IG-M8 / IG-M10	20x85	85	1,3		0,19	0,39			
	20x130	130							
	20x200	200							
ESSVE Injection system ONE, ONE ICE for masonry							Annex C 8		
Performances calcium solid brick KS-NF									
Characteristic values of resistance under tension and shear load (continue) Displacements									

Brick type: Calcium silicate hollow brick KS L-3DF

Table C18: Description of the brick

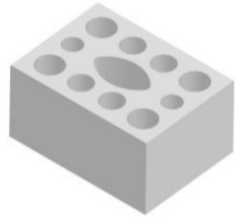
Brick type	Calcium silicate hollow brick KSL-3DF	
Bulk density ρ [kg/dm ³]	1,4	
Compressive strength $f_b \geq$ [N/mm ²]	8, 12 or 14	
Code	EN 771-2	
Producer (country code)	e.g. Wemding (DE)	
Brick dimensions [mm]	240 x 175 x 113	
Drilling method	Rotary	

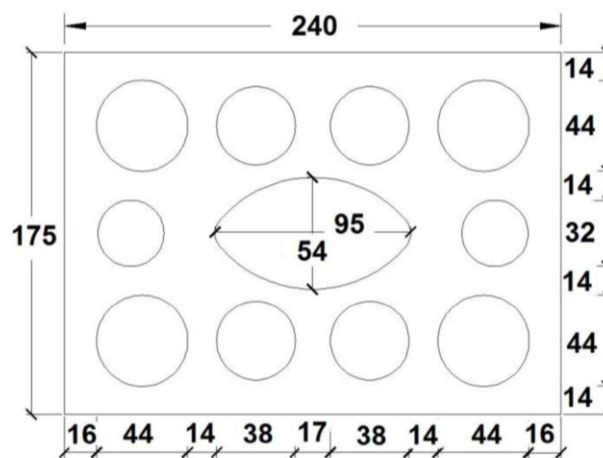
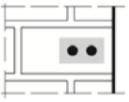
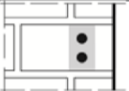

Table C19: Installation parameters

Anchor size		[-]	All sizes
Edge distance	C_{cr}	[mm]	100 (120) ¹⁾
Minimum edge distance	C_{min}	[mm]	60
Spacing	$S_{cr,II}$	[mm]	240
	$S_{cr,\perp}$	[mm]	120
Minimum spacing	S_{min}	[mm]	120

¹⁾ Value in brackets for SH20x85; SH20x130 and SH20x200

Table C20: Group factor for anchor group in case of tension loading

Configuration		with $c \geq$	with $s \geq$			
II: anchors placed parallel to horizontal joint		60	120	$\alpha_{g,N,II}$	[-]	1,5
		C_{cr}	240			2,0
		160	120			2,0
⊥: anchors placed perpendicular to horizontal joint		60	120	$\alpha_{g,N,\perp}$	[-]	1,0
		C_{cr}	120			2,0

ESSVE Injection system ONE, ONE ICE for masonry

Performances calcium hollow brick KS L-3DF

Description of the brick
Installation parameters

Annex C 9

Brick type: Calcium silicate hollow brick KS L-3DF

Table C21: Group factor for anchor group in case of shear loading parallel to free edge

Configuration		with $c \geq$	with $s \geq$			
II: anchors placed parallel to horizontal joint		60	120	$\alpha_{g,V,II}$	[-]	1,0
		160	120			1,6
		c_{Cr}	240			2,0
⊥: anchors placed perpendicular to horizontal joint		60	120	$\alpha_{g,V,\perp}$	[-]	1,0
		c_{Cr}	120			2,0

Table C22: Group factor for anchor group in case of shear loading perpendicular to free edge

Configuration		with $c \geq$	with $s \geq$			
II: anchors placed parallel to horizontal joint		60	120	$\alpha_{g,V,II}$	[-]	1,0
		c_{Cr}	240			2,0
		⊥: anchors placed perpendicular to horizontal joint				60
c_{Cr}	120			2,0		

Table C23: Characteristic values of resistance under tension and shear loads

Anchor size	Sleeve	Effective anchorage depth	Characteristic resistance						
			Use category						
			d/d			w/d; w/w			d/d; w/d; w/w
			40°C/24°C	80°C/50°C	120°C/72°C	40°C/24°C	80°C/50°C	120°C/72°C	For all temperature range
		h_{ef}	$N_{RK,b} = N_{RK,p}^{1)}$			$N_{RK,b} = N_{RK,p}^{1)}$			$V_{RK,b}^{4)}$
		[mm]	[kN]						
Compressive strength $f_b \geq 8 \text{ N/mm}^2$									
M8	12x80	80	1,5	1,5	1,2	1,5	1,2	0,9	$2,5^{2)}$ ($0,9^{3)}$
M8 / M10 / IG-M6	16x85	85	1,5	1,5	1,2	1,5	1,5	1,2	$4,0^{2)}$ ($1,5^{3)}$
	16x130	130	1,5	1,5	1,2	1,5	1,5	1,2	$4,0^{2)}$ ($1,5^{3)}$
M12 / M16 / IG-M8 / IG-M10	20x85	85	4,5	4,0	3,0	4,5	4,0	3,0	$4,0^{2)}$ ($1,5^{3)}$
	20x130	130	4,5	4,0	3,0	4,5	4,0	3,0	$4,0^{2)}$ ($1,5^{3)}$
	20x200	200	4,5	4,0	3,0	4,5	4,0	3,0	$4,0^{2)}$ ($1,5^{3)}$
Compressive strength $f_b \geq 12 \text{ N/mm}^2$									
M8	12x80	80	2,0	2,0	1,5	2,0	1,5	1,2	$3,0^{2)}$ ($1,2^{3)}$
M8 / M10 / IG-M6	16x85	85	2,0	2,0	1,5	2,0	2,0	1,5	$4,5^{2)}$ ($1,5^{3)}$
	16x130	130	2,5	2,5	1,5	2,5	2,5	1,5	$4,5^{2)}$ ($1,5^{3)}$
M12 / M16 / IG-M8 / IG-M10	20x85	85	6,0	5,5	4,0	6,0	5,5	4,0	$4,5^{2)}$ ($1,5^{3)}$
	20x130	130	6,0	5,5	4,0	6,0	5,5	4,0	$4,5^{2)}$ ($1,5^{3)}$
	20x200	200	6,0	5,5	4,0	6,0	5,5	4,0	$4,5^{2)}$ ($1,5^{3)}$

¹⁾ Values are valid for c_{Cr} and c_{min}

²⁾ $V_{RK,c,II} = V_{RK,b}$ valid for shear load parallel to free edge

³⁾ $V_{RK,c,\perp} = V_{RK,b}$ (values in brackets) valid for shear load in direction to free edge

⁴⁾ The values are valid for steel 5.6 or greater. For steel 4.6 and 4.8 multiply $V_{RK,b}$ by 0,8

ESSVE Injection system ONE, ONE ICE for masonry	Annex C 10
Performances calcium hollow brick KS L-3DF	
Installation parameters (continue) Characteristic values of resistance under tension and shear load	

Brick type: Calcium silicate hollow brick KS L-3DF

Table C24: Characteristic values of resistance under tension and shear loads (continue)

Anchor size	Sleeve	Effective anchorage depth	Characteristic resistance						
			Use category						
			d/d			w/d w/w			d/d; w/d; w/w
			40°C/24°C	80°C/50°C	120°C/72°C	40°C/24°C	80°C/50°C	120°C/72°C	For all temperature range
		h_{ef}	$N_{Rk,b} = N_{Rk,p}^{1)}$			$N_{Rk,b} = N_{Rk,p}^{1)}$			$V_{Rk,b}^{4)}$
		[mm]	[kN]						
Compressive strength $f_b \geq 14 \text{ N/mm}^2$									
M8	12x80	80	2,5	2,5	1,5	2,0	2,0	1,5	$3,5^{2)}$ ($1,5^{3)}$
M8 / M10 / IG-M6	16x85	85	2,5	2,5	1,5	2,5	2,5	1,5	$6,0^{2)}$ ($2,0^{3)}$
	16x130	130	2,5	2,5	2,0	2,5	2,5	2,0	$6,0^{2)}$ ($2,0^{3)}$
M12 / M16 / IG-M8 / IG-M10	20x85	85	6,5	6,0	4,5	6,5	6,0	4,5	$6,0^{2)}$ ($2,0^{3)}$
	20x130	130	6,5	6,0	4,5	6,5	6,0	4,5	$6,0^{2)}$ ($2,0^{3)}$
	20x200	200	6,5	6,0	4,5	6,5	6,0	4,5	$6,0^{2)}$ ($2,0^{3)}$

1) Values are valid for C_{cr} and C_{min}

2) $V_{Rk,c,II} = V_{Rk,b}$ valid for shear load parallel to free edge

3) $V_{Rk,c,I} = V_{Rk,b}$ (values in brackets) valid for shear load in direction to free edge

4) The values are valid for steel 5.6 or greater. For steel 4.6 and 4.8 multiply $V_{Rk,b}$ by 0,8

Table C25: Displacements

Anchor size	Sleeve	Effective anchorage depth h_{ef}	N	δ_N / N	δ_{N0}	$\delta_{N\infty}$	V	δ_{V0}	$\delta_{V\infty}$
			[kN]	[mm/kN]	[mm]	[mm]	[kN]	[mm]	[mm]
M8	12x80	80	0,71	0,90	0,64	1,29	1,0	1,0	1,50
M8 / M10 / IG-M6	16x85	85					1,86	1,67	3,34
	16x130	130							
M12 / M16 / IG-M8 / IG-M10	20x85	85							
	20x130	130							
	20x200	200							

ESSVE Injection system ONE, ONE ICE for masonry

Performances calcium hollow brick KS L-3DF

Characteristic values of resistance under tension and shear load (continue)

Displacements

Annex C 11

Brick type: Calcium silicate hollow brick KS L-12DF

Table C26: Description of the brick

Brick type	Calcium silicate hollow brick KSL-12DF	
Bulk density ρ [kg/dm ³]	1,4	
Compressive strength $f_b \geq$ [N/mm ²]	10, 12 or 16	
Code	EN 771-2	
Producer (country code)	e.g. Wemding (DE)	
Brick dimensions [mm]	498 x 175 x 238	
Drilling method	Rotary	

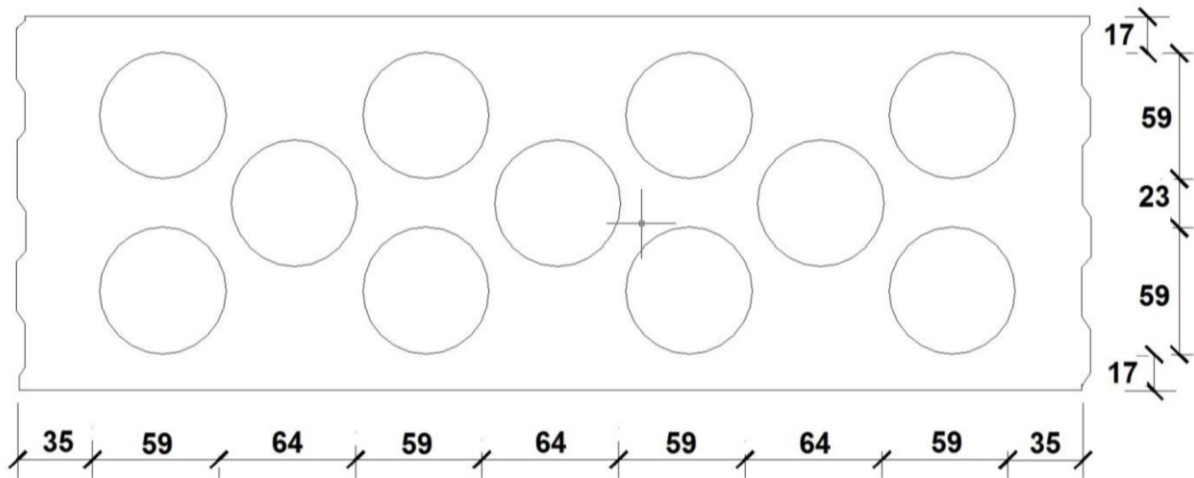



Table C27: Installation parameters

Anchor size		[-]	All sizes
Edge distance	C_{cr}	[mm]	100 (120) ¹⁾
Minimum edge distance	C_{min} ²⁾	[mm]	100 (120) ¹⁾
Spacing	$S_{cr,II}$	[mm]	498
	$S_{cr,\perp}$	[mm]	238
Minimum spacing	S_{min}	[mm]	120

¹⁾ Value in brackets for SH20x85 and SH20x130

²⁾ For $V_{Rk,c}$: C_{min} according to Technical Report TR 054

Table C28: Group factor for anchor group in case of tension loading

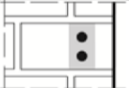
Configuration		with $c \geq$	with $s \geq$	$\alpha_{g,N,II}$	[-]	
II: anchors placed parallel to horizontal joint		100	120			
		C_{cr}	498	2,0		
\perp : anchors placed perpendicular to horizontal joint		100	120	$\alpha_{g,N,\perp}$		1,0
		C_{cr}	238			2,0

ESSVE Injection system ONE, ONE ICE for masonry

Performances Calcium hollow brick KS L-12DF

Description of the brick
Installation parameters

Annex C 12

Brick type: Calcium silicate hollow brick KS L-12DF

Table C29: Group factor for anchor group in case of shear loading parallel to free edge

Configuration		with $c \geq$	with $s \geq$			
II: anchors placed parallel to horizontal joint		C_{Cr}	498	$\alpha_{g,V,II}$	[-]	2,0
I: anchors placed perpendicular to horizontal joint		C_{Cr}	238	$\alpha_{g,V,I}$		2,0

Table C30: Group factor for anchor group in case of shear loading perpendicular to free edge

Configuration		with $c \geq$	with $s \geq$			
II: anchors placed parallel to horizontal joint		C_{Cr}	498	$\alpha_{g,V,II}$	[-]	2,0
I: anchors placed perpendicular to horizontal joint		C_{Cr}	238	$\alpha_{g,V,I}$		2,0

Table C31: Characteristic values of resistance under tension and shear loads

Anchor size	Sleeve	Effective anchorage depth	Characteristic resistance						
			Use category						
			d/d			w/d w/w			d/d w/d w/w
			40°C/24°C	80°C/50°C	120°C/72°C	40°C/24°C	80°C/50°C	120°C/72°C	For all temperature range
		h_{ef}	$N_{RK,b} = N_{RK,p}^{1)}$			$N_{RK,b} = N_{RK,p}^{1)}$			$V_{RK,b}^{2)3)}$
		[mm]	[kN]						
Compressive strength $f_b \geq 10 \text{ N/mm}^2$									
M8	12x80	80	0,6	0,6	0,4	0,5	0,5	0,4	2,5
M8 / M10 / IG-M6	16x85	85	0,6	0,6	0,4	0,6	0,6	0,4	5,5
	16x130	130	2,5	2,5	2,0	2,5	2,5	2,0	5,5
M12 / M16 / IG-M8 / IG-M10	20x85	85	1,5	1,5	0,9	1,5	1,5	0,9	5,5
	20x130	130	2,5	2,5	2,0	2,5	2,5	2,0	5,5
Compressive strength $f_b \geq 12 \text{ N/mm}^2$									
M8	12x80	80	0,75	0,6	0,5	0,6	0,6	0,4	3,0
M8 / M10 / IG-M6	16x85	85	0,75	0,6	0,5	0,75	0,6	0,5	6,5
	16x130	130	3,0	3,0	2,0	3,0	3,0	2,0	6,5
M12 / M16 / IG-M8 / IG-M10	20x85	85	1,5	1,5	1,2	1,5	1,5	1,2	6,5
	20x130	130	3,0	3,0	2,0	3,0	3,0	2,0	6,5

¹⁾ Values are valid for C_{Cr} and C_{min}

²⁾ Calculation of $V_{RK,c}$ see Technical Report TR 054, except for shear load parallel to free edge with $c \geq 120 \text{ mm}$: $V_{RK,c,II} = V_{RK,b}$

³⁾ The values are valid for steel 5.6 or greater. For steel 4.6 and 4.8 multiply $V_{RK,b}$ by 0,8

ESSVE Injection system ONE, ONE ICE for masonry

Performances calcium hollow brick KS L-12DF

Installation parameters (continue)

Characteristic values of resistance under tension and shear load

Annex C 13

Brick type: Calcium silicate hollow brick KS L-12DF

Table C32: Characteristic values of resistance under tension and shear loads (continue)

Anchor size	Sleeve	Effective anchorage depth	Characteristic resistance						
			Use category						
			d/d			w/d w/w			d/d w/d w/w
			40°C/24°C	80°C/50°C	120°C/72°C	40°C/24°C	80°C/50°C	120°C/72°C	For all temperature range
		h_{ef}	$N_{Rk,b} = N_{Rk,p}^{1)}$			$N_{Rk,b} = N_{Rk,p}^{1)}$			$V_{Rk,b}^{2)3)}$
		[mm]	[kN]						
Compressive strength $f_b \geq 16 \text{ N/mm}^2$									
M8	12x80	80	0,9	0,9	0,6	0,75	0,75	0,5	3,5
M8 / M10 / IG-M6	16x85	85	0,9	0,9	0,6	0,9	0,9	0,6	8,0
	16x130	130	4,0	3,5	2,5	4,0	3,5	2,5	8,0
M12 / M16 / IG-M8 / IG-M10	20x85	85	2,0	2,0	1,5	2,0	2,0	1,5	8,0
	20x130	130	4,0	3,5	2,5	4,0	3,5	2,5	8,0

1) Values are valid for C_{cr} and C_{min}

2) Calculation of $V_{Rk,c}$ see Technical Report TR 054, except for shear load parallel to free edge with $c \geq 120 \text{ mm}$: $V_{Rk,c,II} = V_{Rk,b}$

3) The values are valid for steel 5.6 or greater. For steel 4.6 and 4.8 multiply $V_{Rk,b}$ by 0,8

Table C33: Displacements

Anchor size	Sleeve	Effective anchorage depth h_{ef} [mm]	N [kN]	δ_N / N [mm/kN]	δ_{N0} [mm]	$\delta_{N\infty}$ [mm]	V [kN]	δ_{V0} [mm]	$\delta_{V\infty}$ [mm]
M8 / M10 / IG-M6	16x85	85	1,14	1,03	2,06				
	M12 / M16 / IG-M8 / IG-M10	16x130	130	0,57	0,51	1,03	2,3	2,5	3,75
20x85		85	1,14	1,03	2,06				
	20x130	130							

ESSVE Injection system ONE, ONE ICE for masonry

Performances calcium hollow brick KS L-12DF

Characteristic values of resistance under tension and shear load (continue)

Displacements

Annex C 14

Brick type: Clay solid brick Mz-DF

Table C34: Description of the brick

Brick type	Clay solid brick Mz-DF	
Bulk density ρ [kg/dm ³]	1,6	
Compressive strength $f_b \geq$ [N/mm ²]	10, 20 or 28	
Code	EN 771-1	
Producer (country code)	e.g. Unipor (DE)	
Brick dimensions [mm]	240 x 115 x 55	
Drilling method	Hammer	

Table C35: Installation parameter

Anchor size		[-]	All sizes
Edge distance	c_{cr}	[mm]	$1,5 \cdot h_{ef}$
Minimum edge distance	c_{min}	[mm]	60
Spacing	s_{cr}	[mm]	$3 \cdot h_{ef}$
Minimum spacing	s_{min}	[mm]	120

Table C36: Group factor for anchor group in case of tension loading

Configuration		with $c \geq$	with $s \geq$			
II: anchors placed parallel to horizontal joint		60	120	$\alpha_{g,N,II}$	[-]	0,7
		$1,5 \cdot h_{ef}$	$3 \cdot h_{ef}$			2,0
⊥: anchors placed perpendicular to horizontal joint		60	120	$\alpha_{g,N,\perp}$	[-]	0,5
		$1,5 \cdot h_{ef}$	120			1,0
		$1,5 \cdot h_{ef}$	$3 \cdot h_{ef}$			2,0

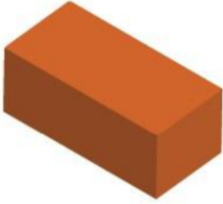
Table C37: Group factor for anchor group in case of shear loading parallel to free edge



Configuration		with $c \geq$	with $s \geq$			
II: anchors placed parallel to horizontal joint		60	120	$\alpha_{g,V,II}$	[-]	0,5
		90	120			1,1
		$1,5 \cdot h_{ef}$	$3 \cdot h_{ef}$			2,0
⊥: anchors placed perpendicular to horizontal joint		60	120	$\alpha_{g,V,\perp}$	[-]	0,5
		$1,5 \cdot h_{ef}$	120			1,0
		$1,5 \cdot h_{ef}$	$3 \cdot h_{ef}$			2,0

Table C38: Group factor for anchor group in case of shear loading perpendicular to free edge

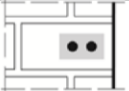
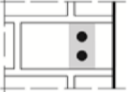
Configuration		with $c \geq$	with $s \geq$			
II: anchors placed parallel to horizontal joint		60	120	$\alpha_{g,V,II}$	[-]	0,5
		$1,5 \cdot h_{ef}$	120			1,0
		$1,5 \cdot h_{ef}$	$3 \cdot h_{ef}$			2,0
⊥: anchors placed perpendicular to horizontal joint		60	120	$\alpha_{g,V,\perp}$	[-]	0,5
		$1,5 \cdot h_{ef}$	120			1,0
		$1,5 \cdot h_{ef}$	$3 \cdot h_{ef}$			2,0

ESSVE Injection system ONE, ONE ICE for masonry

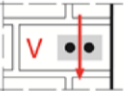
Performances clay solid brick Mz-DF

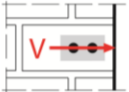
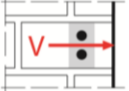
Description of the brick
Installation parameters

Annex C 15

Brick type: Clay solid brick Mz-DF

Table C39: Characteristic values of resistance under tension and shear loads

Anchor size	Sleeve	Effective anchorage depth	Characteristic resistance			
			Use category			
			d/d w/d w/w			d/d w/d w/w
			40°C/24°C	80°C/50°C	120°C/72°C	For all temperature range
h_{ef}		$N_{Rk,b} = N_{Rk,p}^{1)}$			$V_{Rk,b}^{2)3)}$	
[mm]		[kN]				
Compressive strength $f_b \geq 10 \text{ N/mm}^2$						
M8	-	80	3,5 (1,5)	3,5 (1,5)	2,5 (1,2)	3,5 (1,2)
M10 / IG-M6	-	90	3,5 (1,5)	3,5 (1,5)	3,0 (1,5)	3,5 (1,2)
M12 / IG-M8	-	100	4,0 (2,0)	4,0 (2,0)	3,5 (1,5)	3,5 (1,2)
M16 / IG-M10	-	100	4,0 (2,0)	4,0 (2,0)	3,5 (1,5)	5,5 (1,5)
M8	12x80	80	3,5 (1,5)	3,5 (1,5)	3,0 (1,2)	3,5 (1,2)
M8 / M10 / IG-M6	16x85	85	3,5 (1,5)	3,5 (1,5)	3,0 (1,5)	3,5 (1,2)
	16x130	130	3,5 (1,5)	3,5 (1,5)	3,0 (1,5)	3,5 (1,2)
M12 / M16 / IG-M8 / IG-M10	20x85	85	3,5 (1,5)	3,5 (1,5)	3,0 (1,5)	3,5 (1,2)
	20x130	130	3,5 (1,5)	3,5 (1,5)	3,0 (1,5)	3,5 (1,2)
	20x200	200	3,5 (1,5)	3,5 (1,5)	3,0 (1,5)	3,5 (1,2)
Compressive strength $f_b \geq 20 \text{ N/mm}^2$						
M8	-	80	4,5 (2,5)	4,5 (2,5)	4,0 (2,0)	5,0 (1,5)
M10 / IG-M6	-	90	5,5 (2,5)	5,5 (2,5)	4,5 (2,0)	5,0 (1,5)
M12 / IG-M8	-	100	6,0 (3,0)	6,0 (3,0)	5,0 (2,5)	5,0 (1,5)
M16 / IG-M10	-	100	6,0 (3,0)	6,0 (3,0)	5,0 (2,5)	8,0 (2,5)
M8	12x80	80	4,5 (2,5)	4,5 (2,5)	4,0 (2,0)	5,0 (1,5)
M8 / M10 / IG-M6	16x85	85	5,0 (2,5)	5,0 (2,5)	4,0 (2,0)	5,0 (1,5)
	16x130	130	5,0 (2,5)	5,0 (2,5)	4,0 (2,0)	5,0 (1,5)
M12 / M16 / IG-M8 / IG-M10	20x85	85	5,0 (2,5)	5,0 (2,5)	4,0 (2,0)	5,0 (1,5)
	20x130	130	5,0 (2,5)	5,0 (2,5)	4,0 (2,0)	5,0 (1,5)
	20x200	200	5,0 (2,5)	5,0 (2,5)	4,0 (2,0)	5,0 (1,5)
Compressive strength $f_b \geq 28 \text{ N/mm}^2$						
M8	-	80	5,5 (2,5)	5,5 (2,5)	4,5 (2,5)	5,5 (2,0)
M10 / IG-M6	-	90	6,0 (3,0)	6,0 (3,0)	5,0 (2,5)	5,5 (2,0)
M12 / IG-M8	-	100	7,0 (3,5)	7,0 (3,5)	6,0 (3,0)	5,5 (2,0)
M16 / IG-M10	-	100	7,0 (3,5)	7,0 (3,5)	6,0 (3,0)	9,0 (3,0)
M8	12x80	80	5,5 (2,5)	5,5 (2,5)	4,5 (2,5)	5,5 (2,0)
M8 / M10 / IG-M6	16x85	85	6,0 (3,0)	6,0 (3,0)	5,0 (2,5)	5,5 (2,0)
	16x130	130	6,0 (3,0)	6,0 (3,0)	5,0 (2,5)	5,5 (2,0)
M12 / M16 / IG-M8 / IG-M10	20x85	85	6,0 (3,0)	6,0 (3,0)	5,0 (2,5)	5,5 (2,0)
	20x130	130	6,0 (3,0)	6,0 (3,0)	5,0 (2,5)	5,5 (2,0)
	20x200	200	6,0 (3,0)	6,0 (3,0)	5,0 (2,5)	5,5 (2,0)
¹⁾ Values are valid for c_{cr} , values in brackets are valid for single anchors with c_{min} ²⁾ For c_{cr} calculation of $V_{Rk,c}$ see Technical Report TR 054; for c_{min} values in brackets $V_{Rk,b} = V_{Rk,c}$ ³⁾ The values are valid for steel 5.6 or greater. For steel 4.6 and 4.8 multiply $V_{Rk,b}$ by 0,8						
ESSVE Injection system ONE, ONE ICE for masonry					Annex C 16	
Performances clay solid brick Mz-DF Characteristic values of resistance under tension and shear load						

Brick type: Clay solid brick Mz-DF

Table C40: Displacements

Anchor size	Sleeve	Effective anchorage depth h_{ef}	N	δ_N / N	δ_{N0}	$\delta_{N\infty}$	V	δ_{V0}	$\delta_{V\infty}$
		[mm]	[kN]	[mm/kN]	[mm]	[mm]	[kN]	[mm]	[mm]
M8	-	80	1,3	0,15	0,19	0,39	1,9	1,00	1,50
M10 / IG-M6	-	90	1,6		0,24	0,47			
M12 / IG-M8	-	100	1,7		0,26	0,51			
M16 / IG-M10	-	100							
M8	12x80	80	1,3		0,19	0,39	1,9		
M8 / M10 / IG-M6	16x85	85							
	16x130	130							
M12 / M16 / IG-M8 / IG-M10	20x85	85							
	20x130	130							
	20x200	200							

ESSVE Injection system ONE, ONE ICE for masonry

Performances clay solid brick Mz-DF
Displacements

Annex C 17

Brick type: Clay hollow brick HLz-16-DF

Table C41: Description of the brick

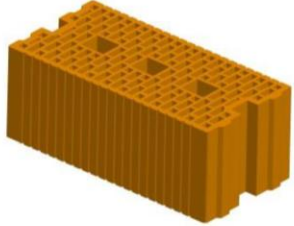
Brick type	Clay hollow brick HLz-16-DF	
Bulk density ρ [kg/dm ³]	0,8	
Compressive strength $f_b \geq$ [N/mm ²]	6, 8, 12, 14	
Code	EN 771-1	
Producer (country code)	e.g. Unipor DE	
Brick dimensions [mm]	497 x 240 x 238	
Drilling method	Rotary	

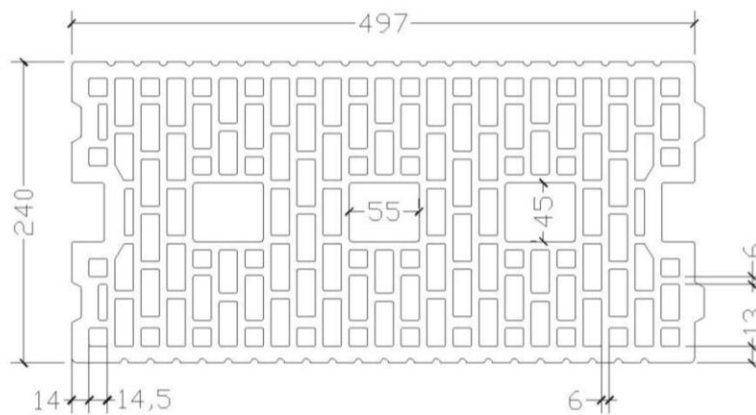



Table C42: Installation parameters

Anchor size		[-]	All sizes
Edge distance	C_{cr}	[mm]	100 (120) ¹⁾
Minimum edge distance	C_{min} ²⁾	[mm]	100 (120) ¹⁾
Spacing	$S_{cr,II}$	[mm]	497
	$S_{cr,I}$	[mm]	238
Minimum spacing	S_{min}	[mm]	100

¹⁾ Value in brackets for SH20x85; SH20x130 and SH20x200

²⁾ For $V_{Rk,c}$: C_{min} according to Technical Report TR 054

Table C43: Group factor for anchor group in case of tension loading

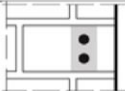
Configuration		with $c \geq$	with $s \geq$			
II: anchors placed parallel to horizontal joint		C_{cr}	100	$\alpha_{g,N,II}$	[-]	1,3
		C_{cr}	497			2,0
I: anchors placed perpendicular to horizontal joint		C_{cr}	100	$\alpha_{g,N,I}$		1,1
		C_{cr}	238			2,0

ESSVE Injection system ONE, ONE ICE for masonry

Performances clay hollow brick HLz-16DF

Description of the brick
Installation parameters

Annex C 18

Brick type: Clay hollow brick HLz-16-DF

Table C44: Group factor for anchor group in case of shear loading parallel to free edge

Configuration		with $c \geq$	with $s \geq$			
II: anchors placed parallel to horizontal joint		C_{cr}	497	$\alpha_{g,V,II}$	[-]	2,0
I: anchors placed perpendicular to horizontal joint		C_{cr}	238	$\alpha_{g,V,I}$		2,0

Table C45: Group factor for anchor group in case of shear loading perpendicular to free edge

Configuration		with $c \geq$	with $s \geq$			
II: anchors placed parallel to horizontal joint		C_{cr}	497	$\alpha_{g,V,II}$	[-]	2,0
I: anchors placed perpendicular to horizontal joint		C_{cr}	238	$\alpha_{g,V,I}$		2,0

Table C46: Characteristic values of resistance under tension and shear loads

Anchor size	Sleeve	Effective anchorage depth	Characteristic resistance			
			Use category			
			d/d w/d w/w			d/d w/d w/w
			40°C/24°C	80°C/50°C	120°C/72°C	For all temperature range
		h_{ef}	$N_{Rk,b} = N_{Rk,p}^{1)}$			$V_{Rk,b}^{2)3)}$
		[mm]	[kN]			
Compressive strength $f_b \geq 6 \text{ N/mm}^2$						
M8	12x80	80	2,5	2,5	2,0	2,5
M8 / M10/ IG-M6	16x85	85	2,5	2,5	2,0	4,5
	16x130	130	3,5	3,5	3,0	4,5
M12 / M16 / IG-M8 / IG-M10	20x85	85	2,5	2,5	2,0	5,0
	20x130	130	3,5	3,5	3,0	6,0
	20x200	200	3,5	3,5	3,0	6,0
Compressive strength $f_b \geq 8 \text{ N/mm}^2$						
M8	12x80	80	3,0	3,0	2,5	3,0
M8 / M10/ IG-M6	16x85	85	3,0	3,0	2,5	5,5
	16x130	130	4,5	4,5	3,5	5,5
M12 / M16 / IG-M8 / IG-M10	20x85	85	3,0	3,0	2,5	6,0
	20x130	130	4,5	4,5	3,5	7,0
	20x200	200	4,5	4,5	3,5	7,0

1) Values are valid for C_{cr} and C_{min}

2) Calculation of $V_{Rk,c}$ see Technical Report TR 054, except for shear load parallel to free edge with $c \geq 125 \text{ mm}$: $V_{Rk,c,II} = V_{Rk,b}$

3) The values are valid for steel 5.6 or greater. For steel 4.6 and 4.8 multiply $V_{Rk,b}$ by 0,8

ESSVE Injection system ONE, ONE ICE for masonry

Performances clay hollow brick HLz-16DF

Installation parameters (continue)

Characteristic values of resistance under tension and shear load

Annex C 19

Brick type: Clay hollow brick HLz-16-DF

Table C47: Characteristic values of resistance under tension and shear loads (continue)

Anchor size	Sleeve	Effective anchorage depth	Characteristic resistance			
			Use category			
			d/d w/d w/w			d/d w/d w/w
			40°C/24°C	80°C/50°C	120°C/72°C	For all temperature range
h_{ef}		$N_{Rk,b} = N_{Rk,p}^{1)}$			$V_{Rk,b}^{2)3)}$	
[mm]		[kN]				
Compressive strength $f_b \geq 12 \text{ N/mm}^2$						
M8	12x80	80	3,5	3,5	3,0	4,0
M8 / M10/ IG-M6	16x85	85	3,5	3,5	3,0	6,5
	16x130	130	5,0	5,0	4,5	6,5
M12 / M16 / IG-M8 / IG-M10	20x85	85	3,5	3,5	3,0	7,0
	20x130	130	5,0	5,0	4,5	9,0
	20x200	200	5,0	5,0	4,5	9,0
Compressive strength $f_b \geq 14 \text{ N/mm}^2$						
M8	12x80	80	4,0	4,0	3,0	4,0
M8 / M10/ IG-M6	16x85	85	4,0	4,0	3,0	6,5
	16x130	130	5,5	5,5	4,5	6,5
M12 / M16 / IG-M8 / IG-M10	20x85	85	4,0	4,0	3,0	7,0
	20x130	130	5,5	5,5	4,5	9,0
	20x200	200	5,5	5,5	4,5	9,0

1) Values are valid for c_{cr} and c_{min}

2) Calculation of $V_{Rk,c}$ see Technical Report TR 054, except for shear load parallel to free edge with $c \geq 125 \text{ mm}$: $V_{Rk,c,II} = V_{Rk,b}$

3) The values are valid for steel 5.6 or greater. For steel 4.6 and 4.8 multiply $V_{Rk,b}$ by 0,8

Table C48: Displacements

Anchor size	Sleeve	Effective anchorage depth h_{ef}	N	δ_N / N	δ_{N0}	$\delta_{N\infty}$	V	δ_{V0}	$\delta_{V\infty}$
M8	12x80	80	1,14	0,10	0,11	0,23	1,10	1,20	1,80
M8 / M10/ IG-M6	16x85	85							
	16x130	130	1,57		0,16	0,31	1,86	1,50	2,25
M12 / M16 / IG-M8 / IG-M10	20x85	85	1,14		0,11	0,23	1,86	1,50	2,25
	20x130	130	1,57		0,16	0,31	2,57	2,10	3,15
	20x200	200							

ESSVE Injection system ONE, ONE ICE for masonry

Performances clay hollow brick HLz-16DF

Characteristic values of resistance under tension and shear load (continue)

Displacements

Annex C 20

Brick type: Clay hollow brick Porotherm Homebric

Table C49: Description of the brick

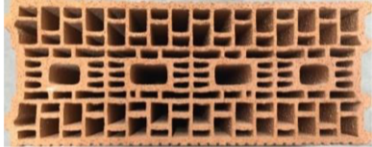
Brick type	Clay hollow hollow brick Porotherm Homebric	
Bulk density ρ [kg/dm ³]	0,7	
Compressive strength $f_b \geq$ [N/mm ²]	4, 6 or 10	
Code	EN 771-1	
Producer (country code)	e.g. Wienerberger (FR)	
Brick dimensions [mm]	500 x 200 x 299	
Drilling method	Rotary	

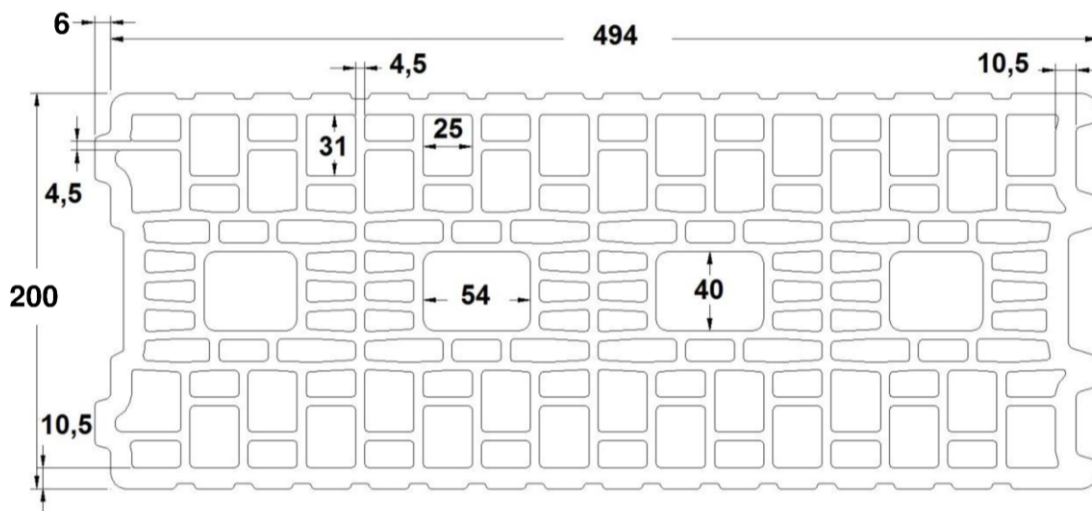

Table C50: Installation parameters

Anchor size		[-]	All sizes
Edge distance	C_{cr}	[mm]	100 (120) ¹⁾
Minimum edge distance	C_{min} ²⁾	[mm]	100 (120) ¹⁾
Spacing	$S_{cr,II}$	[mm]	500
	$S_{cr,\perp}$	[mm]	299
Minimum spacing	S_{min}	[mm]	100

¹⁾ Value in brackets for SH20x85 and SH20x130

²⁾ For $V_{Rk,c}$: C_{min} according to Technical Report TR 054

Table C51: Group factor for anchor group in case of tension loading

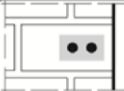
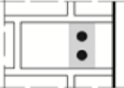
Configuration		with $c \geq$	with $s \geq$			
II: anchors placed parallel to horizontal joint		200	100	$\alpha_{g,N,II}$	[-]	2,0
		C_{cr}	500			2,0
⊥: anchors placed perpendicular to horizontal joint		200	100	$\alpha_{g,N,\perp}$		1,2
		C_{cr}	299			2,0

ESSVE Injection system ONE, ONE ICE for masonry

Performances clay hollow brick Porotherm Homebric

Description of the brick
Installation parameters

Annex C 21

Brick type: Clay silicate hollow brick Porotherm Homebric

Table C52: Group factor for anchor group in case of shear loading parallel to free edge

Configuration		with $c \geq$	with $s \geq$			
II: anchors placed parallel to horizontal joint		C_{cr}	500	$\alpha_{g,V,II}$	[-]	2,0
I: anchors placed perpendicular to horizontal joint		C_{cr}	299	$\alpha_{g,V,I}$		2,0

Table C53: Group factor for anchor group in case of shear loading perpendicular to free edge

Configuration		with $c \geq$	with $s \geq$			
II: anchors placed parallel to horizontal joint		C_{cr}	500	$\alpha_{g,V,II}$	[-]	2,0
I: anchors placed perpendicular to horizontal joint		C_{cr}	299	$\alpha_{g,V,I}$		2,0

Table C54: Characteristic values of resistance under tension and shear loads

Anchor size	Sleeve	Effective anchorage depth	Characteristic resistance			
			Use category			
			d/d w/d w/w			d/d w/d w/w
			40°C/24°C	80°C/50°C	120°C/72°C	For all temperature range
h_{ef}	$N_{Rk,b} = N_{Rk,p}^{1)}$			$V_{Rk,b}^{2)3)}$		
[mm]	[kN]					
Compressive strength $f_b \geq 4 \text{ N/mm}^2$						
M8	12x80	80	0,9	0,9	0,75	2,0
M8 / M10/ IG-M6	16x85	85	0,9	0,9	0,75	2,0
	16x130	130	1,2	1,2	0,9	2,0
M12 / M16 / IG-M8 / IG-M10	20x85	85	0,9	0,9	0,75	2,5
	20x130	130	1,2	1,2	0,9	2,5
Compressive strength $f_b \geq 6 \text{ N/mm}^2$						
M8	12x80	80	0,9	0,9	0,9	2,5
M8 / M10/ IG-M6	16x85	85	0,9	0,9	0,9	2,5
	16x130	130	1,2	1,2	1,2	2,5
M12 / M16 / IG-M8 / IG-M10	20x85	85	0,9	0,9	0,9	3,0
	20x130	130	1,2	1,2	1,2	3,0

1) Values are valid for C_{cr} and C_{min}

2) Calculation of $V_{Rk,c}$ see Technical Report TR 054, except for shear load parallel to free edge with $c \geq 200 \text{ mm}$: $V_{Rk,c,II} = V_{Rk,b}$

3) The values are valid for steel 5.6 or greater. For steel 4.6 and 4.8 multiply $V_{Rk,b}$ by 0,8

ESSVE Injection system ONE, ONE ICE for masonry

Performances clay hollow brick Porotherm Homebric

Installation parameters (continue)

Characteristic values of resistance under tension and shear load

Annex C 22

Brick type: Clay silicate hollow brick Porotherm Homebric

Table C55: Characteristic values of resistance under tension and shear loads (continue)

Anchor size	Sleeve	Effective anchorage depth	Characteristic resistance			
			Use category			
			d/d w/d w/w			d/d w/d w/w
			40°C/24°C	80°C/50°C	120°C/72°C	For all temperature range
h_{ef}		$N_{Rk,b} = N_{Rk,p}^{1)}$			$V_{Rk,b}^{2)3)}$	
[mm]		[kN]				
Compressive strength $f_b \geq 10 \text{ N/mm}^2$						
M8	12x80	80	1,2	1,2	1,2	3,0
M8 / M10/ IG-M6	16x85	85	1,2	1,2	1,2	3,0
	16x130	130	1,5	1,5	1,5	3,5
M12 / M16 / IG-M8 / IG-M10	20x85	85	1,2	1,2	1,2	4,0
	20x130	130	1,5	1,5	1,5	4,0

1) Values are valid for c_{cr} and c_{min}

2) Calculation of $V_{Rk,c}$ see Technical Report TR 054, except for shear load parallel to free edge with $c \geq 200 \text{ mm}$: $V_{Rk,c,II} = V_{Rk,b}$

3) The values are valid for steel 5.6 or greater. For steel 4.6 and 4.8 multiply $V_{Rk,b}$ by 0,8

Table C56: Displacements

Anchor size	Sleeve	Effective anchorage depth h_{ef}	N	δ_N / N	δ_{N0}	$\delta_{N\infty}$	V	δ_{V0}	$\delta_{V\infty}$
			[kN]	[mm/kN]	[mm]	[mm]	[kN]	[mm]	[mm]
M8	12x80	80	0,34	0,80	0,27	0,55	0,9	1,20	1,80
M8 / M10/ IG-M6	16x85	85					0,9		
	16x130	130	0,43		0,34	0,69	1,0		
M12 / M16 / IG-M8 / IG-M10	20x85	85	0,34		0,27	0,55	1,14		
	20x130	130	0,43		0,34	0,69			

ESSVE Injection system ONE, ONE ICE for masonry

Performances clay hollow brick Porotherm Homebric

Characteristic values of resistance under tension and shear load (continue)

Displacements

Annex C 23

Brick type: Clay hollow brick BGV Thermo

Table C57: Description of the brick

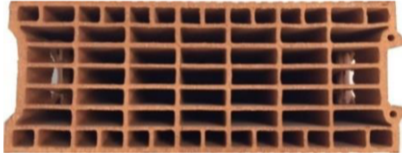
Brick type	Clay hollow brick BGV Thermo	
Bulk density ρ [kg/dm ³]	0,6	
Compressive strength $f_b \geq$ [N/mm ²]	4, 6 or 10	
Code	EN 771-1	
Producer (country code)	e.g. Leroux (FR)	
Brick dimensions [mm]	500 x 200 x 314	
Drilling method	Rotary	

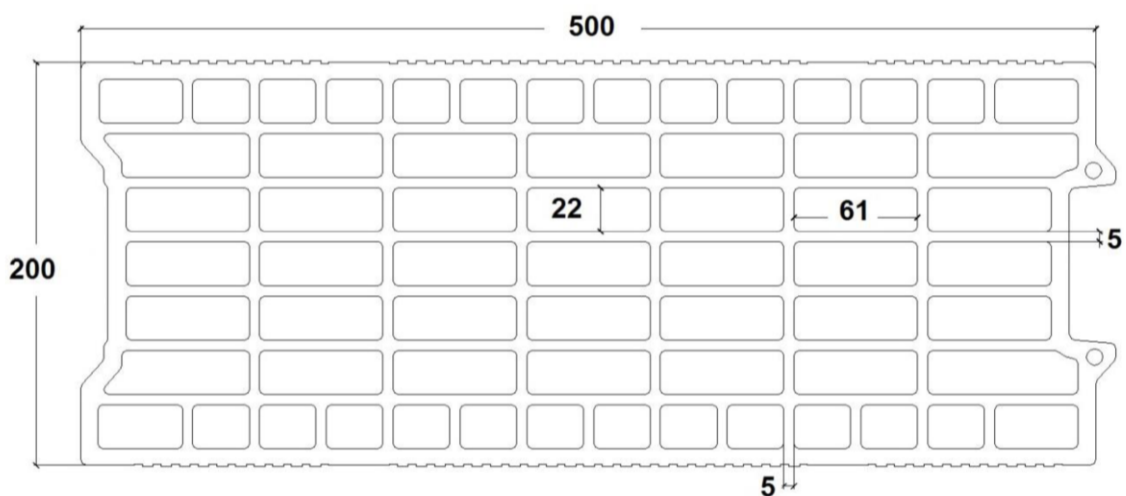

Table C58: Installation parameters

Anchor size		[-]	All sizes
Edge distance	C_{cr}	[mm]	100 (120) ¹⁾
Minimum edge distance	C_{min} ²⁾	[mm]	100 (120) ¹⁾
Spacing	$S_{cr,II}$	[mm]	500
	$S_{cr,\perp}$	[mm]	314
Minimum spacing	S_{min}	[mm]	100

¹⁾ Value in brackets for SH20x85 and SH20x130

²⁾ For $V_{Rk,c}$: C_{min} according to Technical Report TR 054

Table C59: Group factor for anchor group in case of tension loading

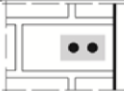
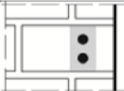
Configuration		with $c \geq$	with $s \geq$	$\alpha_{g,N,II}$	[-]	
II: anchors placed parallel to horizontal joint		200	100			
		C_{cr}	500	2,0		
\perp : anchors placed perpendicular to horizontal joint		200	100	$\alpha_{g,N,\perp}$	1,1	
		C_{cr}	314			2,0

ESSVE Injection system ONE, ONE ICE for masonry

Performances clay hollow brick BGV Thermo

Description of the brick
Installation parameters

Annex C 24

Brick type: Clay hollow brick BGV Thermo

Table C60: Group factor for anchor group in case of shear loading parallel to free edge



Configuration		with $c \geq$	with $s \geq$			
II: anchors placed parallel to horizontal joint		C_{cr}	500	$\alpha_{g,V,II}$	[-]	2,0
⊥: anchors placed perpendicular to horizontal joint		C_{cr}	314	$\alpha_{g,V,\perp}$		2,0

Table C61: Group factor for anchor group in case of shear loading perpendicular to free edge

Configuration		with $c \geq$	with $s \geq$			
II: anchors placed parallel to horizontal joint		C_{cr}	500	$\alpha_{g,V,II}$	[-]	2,0
⊥: anchors placed perpendicular to horizontal joint		C_{cr}	314	$\alpha_{g,V,\perp}$		2,0

ESSVE Injection system ONE, ONE ICE for masonry

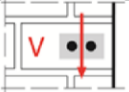
Performances clay hollow brick BGV Thermo
Installation parameters (continue)

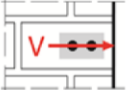
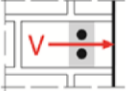
Annex C 25

Brick type: Clay hollow brick BGV Thermo

Table C62: Characteristic values of resistance under tension and shear loads

Anchor size	Sleeve	Effective anchorage depth	Characteristic resistance			
			Use category			
			d/d w/d w/w			d/d w/d w/w
			40°C/24°C	80°C/50°C	120°C/72°C	For all temperature range
h_{ef}	$N_{Rk,b} = N_{Rk,p}^{1)}$			$V_{Rk,b}^{2)3)}$		
[mm]	[kN]					
Compressive strength $f_b \geq 4 \text{ N/mm}^2$						
M8	12x80	80	0,6	0,6	0,6	2,0
M8 / M10/ IG-M6	16x85	85	0,6	0,6	0,6	2,0
	16x130	130	1,2	1,2	0,9	2,5
M12 / M16 / IG-M8 / IG-M10	20x85	85	0,6	0,6	0,6	2,5
	20x130	130	1,2	1,2	0,9	2,5
Compressive strength $f_b \geq 6 \text{ N/mm}^2$						
M8	12x80	80	0,9	0,9	0,75	2,5
M8 / M10/ IG-M6	16x85	85	0,9	0,9	0,75	2,5
	16x130	130	1,5	1,5	1,2	3,0
M12 / M16 / IG-M8 / IG-M10	20x85	85	0,9	0,9	0,75	3,0
	20x130	130	1,5	1,5	1,2	3,0
Compressive strength $f_b \geq 10 \text{ N/mm}^2$						
M8	12x80	80	0,9	0,9	0,9	3,5
M8 / M10/ IG-M6	16x85	85	0,9	0,9	0,9	3,5
	16x130	130	2,0	2,0	1,5	4,0
M12 / M16 / IG-M8 / IG-M10	20x85	85	0,9	0,9	0,9	4,0
	20x130	130	2,0	2,0	1,5	4,0

1) Values are valid for c_{cr} and c_{min}

2) Calculation of $V_{Rk,c}$ see Technical Report TR 054, except for shear load parallel to free edge with $c \geq 250 \text{ mm}$: $V_{Rk,c,II} = V_{Rk,b}$

3) The values are valid for steel 5.6 or greater. For steel 4.6 and 4.8 multiply $V_{Rk,b}$ by 0,8

Table C63: Displacements

Anchor size	Sleeve	Effective anchorage depth h_{ef}	N	δ_N / N	δ_{N0}	$\delta_{N\infty}$	V	δ_{V0}	$\delta_{V\infty}$
M8	12x80	80	0,26	0,80	0,21	0,41	0,7	1,00	1,50
M8 / M10/ IG-M6	16x85	85							
	16x130	130	0,34		0,69	0,86			
M12 / M16 / IG-M8 / IG-M10	20x85	85	0,21		0,41				
	20x130	130	0,34	0,69					

ESSVE Injection system ONE, ONE ICE for masonry

Performances clay hollow brick BGV Thermo

Characteristic values of resistance under tension and shear load
Displacements

Annex C 26

Brick type: Clay hollow brick Calibric R+

Table C64: Description of the brick

Brick type	Clay hollow brick Calibric R+	
Bulk density ρ [kg/dm ³]	0,6	
Compressive strength $f_b \geq$ [N/mm ²]	6, 9 or 12	
Code	EN 771-1	
Producer (country code)	e.g. Terreal (FR)	
Brick dimensions [mm]	500 x 200 x 314	
Drilling method	Rotary	

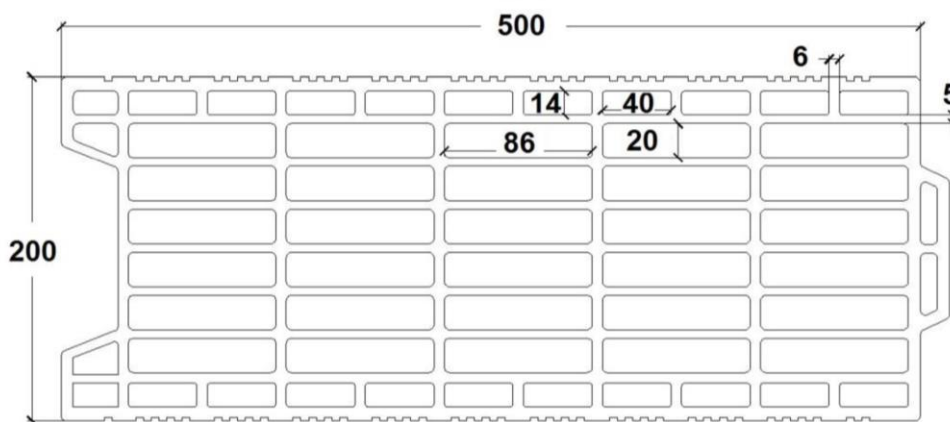

Table C65: Installation parameters

Anchor size		[-]	All sizes
Edge distance	C_{cr}	[mm]	100 (120) ¹⁾
Minimum edge distance	C_{min} ²⁾	[mm]	100 (120) ¹⁾
Spacing	$S_{cr,II}$	[mm]	500
	$S_{cr,I}$	[mm]	314
Minimum spacing	S_{min}	[mm]	100

¹⁾ Value in brackets for SH20x85 and SH20x130

²⁾ For $V_{Rk,c}$: C_{min} according to Technical Report TR 054

Table C66: Group factor for anchor group in case of tension loading

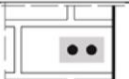
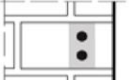
Configuration		with $c \geq$	with $s \geq$			
II: anchors placed parallel to horizontal joint		175	100	$\alpha_{g,N,II}$	[-]	1,7
		C_{cr}	500			2,0
I: anchors placed perpendicular to horizontal joint		175	100	$\alpha_{g,N,I}$	[-]	1,0
		C_{cr}	314			2,0

ESSVE Injection system ONE, ONE ICE for masonry

Performances clay hollow brick Calibric R+

Description of the brick
Installation parameters

Annex C 27

Brick type: Clay hollow brick Calibric R+

Table C67: Group factor for anchor group in case of shear loading parallel to free edge

Configuration		with $c \geq$	with $s \geq$			
II: anchors placed parallel to horizontal joint		C_{cr}	500	$\alpha_{g,V,II}$	[-]	2,0
⊥: anchors placed perpendicular to horizontal joint		C_{cr}	314	$\alpha_{g,V,\perp}$		2,0

Table C68: Group factor for anchor group in case of shear loading perpendicular to free edge

Configuration		with $c \geq$	with $s \geq$			
II: anchors placed parallel to horizontal joint		C_{cr}	500	$\alpha_{g,V,II}$	[-]	2,0
⊥: anchors placed perpendicular to horizontal joint		C_{cr}	314	$\alpha_{g,V,\perp}$		2,0

Table C69: Characteristic values of resistance under tension and shear loads

Anchor size	Sleeve	Effective anchorage depth	Characteristic resistance			
			Use category			
			d/d w/d w/w			d/d w/d w/w
			40°C/24°C	80°C/50°C	120°C/72°C	For all temperature range
		h_{ef}	$N_{RK,b} = N_{RK,p}^{1)}$			$V_{RK,b}^{2)3)}$
		[mm]	[kN]			
Compressive strength $f_b \geq 6 \text{ N/mm}^2$						
M8	12x80	80	0,9	0,9	0,75	3,0
M8 / M10/ IG-M6	16x85	85	0,9	0,9	0,75	4,0
	16x130	130	1,2	1,2	0,9	4,0
M12 / M16 / IG-M8 / IG-M10	20x85	85	0,9	0,9	0,75	6,0
	20x130	130	1,2	1,2	0,9	6,0
Compressive strength $f_b \geq 9 \text{ N/mm}^2$						
M8	12x80	80	1,2	1,2	0,9	3,5
M8 / M10/ IG-M6	16x85	85	1,2	1,2	0,9	5,0
	16x130	130	1,5	1,5	1,2	5,0
M12 / M16 / IG-M8 / IG-M10	20x85	85	1,2	1,2	0,9	7,5
	20x130	130	1,5	1,5	1,2	7,5

1) Values are valid for c_{cr} and c_{min}

2) Calculation of $V_{RK,c}$ see Technical Report TR 054, except for shear load parallel to free edge with $c \geq 250 \text{ mm}$: $V_{RK,c,II} = V_{RK,b}$

3) The values are valid for steel 5.6 or greater. For steel 4.6 and 4.8 multiply $V_{RK,b}$ by 0,8

ESSVE Injection system ONE, ONE ICE for masonry

Performances clay hollow brick Calibric R+

Installation parameters (continue)

Characteristic values of resistance under tension and shear load

Annex C 28

Brick type: Clay hollow brick Calibric R+

Table C70: Characteristic values of resistance under tension and shear loads (continue)

Anchor size	Sleeve	Effective anchorage depth	Characteristic resistance			
			Use category			
			d/d w/d w/w			d/d w/d w/w
			40°C/24°C	80°C/50°C	120°C/72°C	For all temperature range
h_{ef}		$N_{Rk,b} = N_{Rk,p}^{1)}$			$V_{Rk,b}^{2)3)}$	
[mm]		[kN]				
Compressive strength $f_b \geq 12 \text{ N/mm}^2$						
M8	12x80	80	1,2	1,2	0,9	4,0
M8 / M10/ IG-M6	16x85	85	1,2	1,2	0,9	5,5
	16x130	130	1,5	1,5	1,2	5,5
M12 / M16 / IG-M8 / IG-M10	20x85	85	1,2	1,2	0,9	8,5
	20x130	130	1,5	1,5	1,2	8,5

1) Values are valid for c_{cr} and c_{min}

2) Calculation of $V_{Rk,c}$ see Technical Report TR 054, except for shear load parallel to free edge with $c \geq 250 \text{ mm}$: $V_{Rk,c,II} = V_{Rk,b}$

3) The values are valid for steel 5.6 or greater. For steel 4.6 and 4.8 multiply $V_{Rk,b}$ by 0,8

Table C71: Displacements

Anchor size	Sleeve	Effective anchorage depth h_{ef}	N	δ_N / N	δ_{N0}	$\delta_{N\infty}$	V	δ_{V0}	$\delta_{V\infty}$
M8	12x80	80	0,34	0,80	0,27	0,55	1,0	1,10	1,65
M8 / M10/ IG-M6	16x85	85							
		16x130	130	0,43	0,34	0,69	1,43	2,00	3,00
M12 / M16 / IG-M8 / IG-M10	20x85	85	0,34	0,27	0,55	2,14			
		20x130	130	0,43	0,34		0,69		

ESSVE Injection system ONE, ONE ICE for masonry

Performances clay hollow brick Calibric R+

Characteristic values of resistance under tension and shear load (continue)
Displacements

Annex C 29

Brick type: Clay hollow brick Urbanbric

Table C72: Description of the brick

Brick type	Clay hollow brick Urbanbric	
Bulk density ρ [kg/dm ³]	0,7	
Compressive strength $f_b \geq$ [N/mm ²]	6, 9 or 12	
Code	EN 771-1	
Producer (country code)	e.g. Imerys (FR)	
Brick dimensions [mm]	560 x 200 x 274	
Drilling method	Rotary	

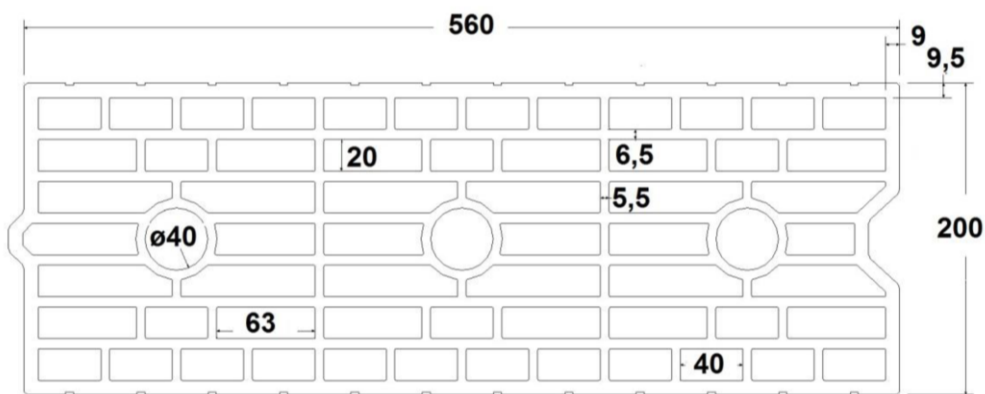

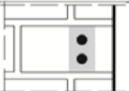

Table C73: Installation parameters

Anchor size		[-]	All sizes
Edge distance	C_{cr}	[mm]	100 (120) ¹⁾
Minimum edge distance	C_{min} ²⁾	[mm]	100 (120) ¹⁾
Spacing	$S_{cr,II}$	[mm]	560
	$S_{cr,\perp}$	[mm]	274
Minimum spacing	S_{min}	[mm]	100

¹⁾ Value in brackets for SH20x85 and SH20x130
²⁾ For $V_{Rk,c}$: C_{min} according to Technical Report TR 054

Table C74: Group factor for anchor group in case of tension loading

Configuration		with $c \geq$	with $s \geq$			
II: anchors placed parallel to horizontal joint		185	100	$\alpha_{g,N,II}$	[-]	1,9
		C_{cr}	560			2,0
⊥: anchors placed perpendicular to horizontal joint		185	100	$\alpha_{g,N,\perp}$		1,1
		C_{cr}	274			2,0

ESSVE Injection system ONE, ONE ICE for masonry

Performances clay hollow brick Urbanbric

Description of the brick
Installation parameters

Annex C 30

Brick type: Clay hollow brick Urbanbric

Table C75: Group factor for anchor group in case of shear loading parallel to free edge

Configuration		with $c \geq$	with $s \geq$			
II: anchors placed parallel to horizontal joint		C_{cr}	560	$\alpha_{g,V,II}$	[-]	2,0
I: anchors placed perpendicular to horizontal joint		C_{cr}	274	$\alpha_{g,V,I}$		2,0

Table C76: Group factor for anchor group in case of shear loading perpendicular to free edge

Configuration		with $c \geq$	with $s \geq$			
II: anchors placed parallel to horizontal joint		C_{cr}	560	$\alpha_{g,V,II}$	[-]	2,0
I: anchors placed perpendicular to horizontal joint		C_{cr}	274	$\alpha_{g,V,I}$		2,0

Table C77: Characteristic values of resistance under tension and shear loads

Anchor size	Sleeve	Effective anchorage depth	Characteristic resistance			
			Use category			
			d/d w/d w/w			d/d w/d w/w
			40°C/24°C	80°C/50°C	120°C/72°C	For all temperature range
		h_{ef}	$N_{Rk,b} = N_{Rk,p}^{1)}$			$V_{Rk,b}^{2)3)}$
		[mm]	[kN]			
Compressive strength $f_b \geq 6 \text{ N/mm}^2$						
M8	12x80	80	0,9	0,9	0,75	3,0
M8 / M10/ IG-M6	16x85	85	0,9	0,9	0,75	3,0
	16x130	130	2,0	2,0	1,5	3,0
M12 / M16 / IG-M8 / IG-M10	20x85	85	0,9	0,9	0,75	3,5
	20x130	130	2,0	2,0	1,5	3,5
Compressive strength $f_b \geq 9 \text{ N/mm}^2$						
M8	12x80	80	0,9	0,9	0,9	4,0
M8 / M10/ IG-M6	16x85	85	0,9	0,9	0,9	4,0
	16x130	130	2,5	2,5	2,0	4,0
M12 / M16 / IG-M8 / IG-M10	20x85	85	0,9	0,9	0,9	4,5
	20x130	130	2,5	2,5	2,0	4,5

1) Values are valid for C_{cr} and C_{min}

2) Calculation of $V_{Rk,c}$ see Technical Report TR 054, except for shear load parallel to free edge with $c \geq 190 \text{ mm}$: $V_{Rk,c,II} = V_{Rk,b}$

3) The values are valid for steel 5.6 or greater. For steel 4.6 and 4.8 multiply $V_{Rk,b}$ by 0,8

ESSVE Injection system ONE, ONE ICE for masonry

Performances clay hollow brick Urbanbric

Installation parameters (continue)

Characteristic values of resistance under tension and shear load

Annex C 31

Brick type: Clay hollow brick Urbanbric

Table C78: Characteristic values of resistance under tension and shear loads (continue)

Anchor size	Sleeve	Effective anchorage depth	Characteristic resistance			
			Use category			
			d/d w/d w/w			d/d w/d w/w
			40°C/24°C	80°C/50°C	120°C/72°C	For all temperature range
h_{ef}		$N_{Rk,b} = N_{Rk,p}^{1)}$			$V_{Rk,b}^{2)3)}$	
[mm]		[kN]				
Compressive strength $f_b \geq 12 \text{ N/mm}^2$						
M8	12x80	80	1,2	1,2	0,9	4,5
M8 / M10/ IG-M6	16x85	85	1,2	1,2	0,9	4,5
	16x130	130	3,0	3,0	2,5	4,5
M12 / M16 / IG-M8 / IG-M10	20x85	85	1,2	1,2	0,9	5,0
	20x130	130	3,0	3,0	2,5	5,0

1) Values are valid for c_{cr} and c_{min}

2) Calculation of $V_{Rk,c}$ see Technical Report TR 054, except for shear load parallel to free edge with $c \geq 190 \text{ mm}$: $V_{Rk,c,II} = V_{Rk,b}$

3) The values are valid for steel 5.6 or greater. For steel 4.6 and 4.8 multiply $V_{Rk,b}$ by 0,8

Table C79: Displacements

Anchor size	Sleeve	Effective anchorage depth h_{ef}	N	δ_N / N	δ_{N0}	$\delta_{N\infty}$	V	δ_{V0}	$\delta_{V\infty}$
		[mm]	[kN]	[mm/kN]	[mm]	[mm]	[kN]	[mm]	[mm]
M8	12x80	80	0,34	0,80	0,27	0,55	1,30	1,00	1,50
M8 / M10/ IG-M6	16x85	85							
	16x130	130	0,86						
M12 / M16 / IG-M8 / IG-M10	20x85	85	0,34		0,27	0,55	1,43		
	20x130	130	0,86		0,69	1,37			
					0,69	1,37			

ESSVE Injection system ONE, ONE ICE for masonry

Performances clay hollow brick Urbanbric

Characteristic values of resistance under tension and shear load (continue)
Displacements

Annex C 32

Brick type: Clay hollow brick Brique creuse C40

Table C80: Description of the brick

Brick type	Clay hollow brick Brique creuse C40
Bulk density ρ [kg/dm ³]	0,7
Compressive strength $f_b \geq$ [N/mm ²]	4, 8 or 12
Code	EN 771-1
Producer (country code)	e.g. Terreal (FR)
Brick dimensions [mm]	500 x 200 x 200
Drilling method	Rotary

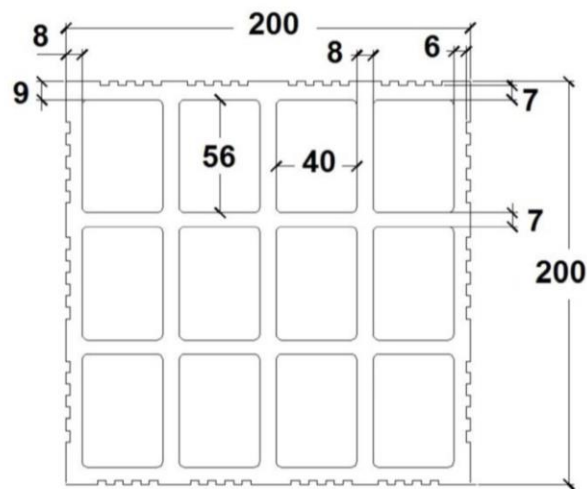

Table C81: Installation parameters

Anchor size		[-]	All sizes
Edge distance	C_{cr}	[mm]	100 (120) ¹⁾
Minimum edge distance	C_{min} ²⁾	[mm]	100 (120) ¹⁾
Spacing	$S_{cr,II}$	[mm]	500
	$S_{cr,\perp}$	[mm]	200
Minimum spacing	S_{min}	[mm]	200

¹⁾ Value in brackets for SH20x85 and SH20x130

²⁾ For $V_{Rk,c}$: C_{min} according to Technical Report TR 054

Table C82: Group factor for anchor group in case of tension loading

Configuration		with $c \geq$	with $s \geq$			
II: anchors placed parallel to horizontal joint		C_{cr}	200	$\alpha_{g,N,II}$	[-]	2,0
⊥: anchors placed perpendicular to horizontal joint		C_{cr}	200	$\alpha_{g,N,\perp}$		2,0

ESSVE Injection system ONE, ONE ICE for masonry

Performances clay hollow brick Brique creuse C40

Description of the brick
Installation parameters

Annex C 33

Brick type: Clay hollow brick Brique creuse C40

Table C83: Group factor for anchor group in case of shear loading parallel to free edge

Configuration		with $c \geq$	with $s \geq$			
II: anchors placed parallel to horizontal joint		C_{cr}	500	$\alpha_{g,V,II}$	[-]	2,0
I: anchors placed perpendicular to horizontal joint		C_{cr}	200	$\alpha_{g,V,I}$		2,0

Table C84: Group factor for anchor group in case of shear loading perpendicular to free edge

Configuration		with $c \geq$	with $s \geq$			
II: anchors placed parallel to horizontal joint		C_{cr}	500	$\alpha_{g,V,II}$	[-]	2,0
I: anchors placed perpendicular to horizontal joint		C_{cr}	200	$\alpha_{g,V,I}$		2,0

Table C85: Characteristic values of resistance under tension and shear loads

Anchor size	Sleeve	Effective anchorage depth	Characteristic resistance			
			Use category			
			d/d w/d w/w			d/d w/d w/w
			40°C/24°C	80°C/50°C	120°C/72°C	For all temperature range
		h_{ef}	$N_{Rk,b} = N_{Rk,p}^{1)}$			$V_{Rk,b}^{2)3)}$
		[mm]	[kN]			
Compressive strength $f_b \geq 4 \text{ N/mm}^2$						
M8	12x80	80	0,6	0,6	0,6	0,9
M8 / M10/ IG-M6	16x85	85	0,6	0,6	0,6	0,9
	16x130	130	0,6	0,6	0,6	0,9
M12 / M16 / IG-M8 / IG-M10	20x85	85	0,6	0,6	0,6	0,9
	20x130	130	0,6	0,6	0,6	0,9
Compressive strength $f_b \geq 8 \text{ N/mm}^2$						
M8	12x80	80	0,9	0,9	0,75	1,2
M8 / M10/ IG-M6	16x85	85	0,9	0,9	0,75	1,2
	16x130	130	0,9	0,9	0,75	1,2
M12 / M16 / IG-M8 / IG-M10	20x85	85	0,9	0,9	0,75	1,2
	20x130	130	0,9	0,9	0,75	1,2

1) Values are valid for C_{cr} and C_{min}

2) Calculation of $V_{Rk,c}$ see Technical Report TR 054

3) The values are valid for steel 5.6 or greater. For steel 4.6 and 4.8 multiply $V_{Rk,b}$ by 0,8

ESSVE Injection system ONE, ONE ICE for masonry

Performances clay hollow brick Brique creuse C40

Installation parameters (continue)

Characteristic values of resistance under tension and shear load

Annex C 34

Brick type: Clay hollow brick Brique creuse C40

Table C86: Characteristic values of resistance under tension and shear loads (continue)

Anchor size	Sleeve	Effective anchorage depth	Characteristic resistance			
			Use category			
			d/d w/d w/w			d/d w/d w/w
			40°C/24°C	80°C/50°C	120°C/72°C	For all temperature range
h_{ef}		$N_{Rk,b} = N_{Rk,p}^{1)}$			$V_{Rk,b}^{2)3)}$	
[mm]		[kN]				
Compressive strength $f_b \geq 12 \text{ N/mm}^2$						
M8	12x80	80	1,2	1,2	0,9	1,5
M8 / M10/ IG-M6	16x85	85	1,2	1,2	0,9	1,5
	16x130	130	1,2	1,2	0,9	1,5
M12 / M16 / IG-M8 / IG-M10	20x85	85	1,2	1,2	0,9	1,5
	20x130	130	1,2	1,2	0,9	1,5

1) Values are valid for c_{cr} and c_{min}

2) Calculation of $V_{Rk,c}$ see Technical Report TR 054

3) The values are valid for steel 5.6 or greater. For steel 4.6 and 4.8 multiply $V_{Rk,b}$ by 0,8

Table C87: Displacements

Anchor size	Sleeve	Effective anchorage depth h_{ef}	N	δ_N / N	δ_{N0}	$\delta_{N\infty}$	V	δ_{V0}	$\delta_{V\infty}$
M8	12x80	80	0,17	0,80	0,14	0,27	0,3	0,9	1,35
M8 / M10/ IG-M6	16x85	85							
	16x130	130							
M12 / M16 / IG-M8 / IG-M10	20x85	85							
	20x130	130							

ESSVE Injection system ONE, ONE ICE for masonry

Performances clay hollow brick Brique creuse C40

Characteristic values of resistance under tension and shear load (continue)
Displacements

Annex C 35

Brick type: Clay hollow brick Blocchi Leggeri

Table C88: Description of the brick

Brick type	Clay hollow brick Blocchi Leggeri	
Bulk density ρ [kg/dm ³]	0,6	
Compressive strength $f_b \geq$ [N/mm ²]	4, 6, 8 or 12	
Code	EN 771-1	
Producer (country code)	e.g. Wienerberger (IT)	
Brick dimensions [mm]	250 x 120 x 250	
Drilling method	Rotary	

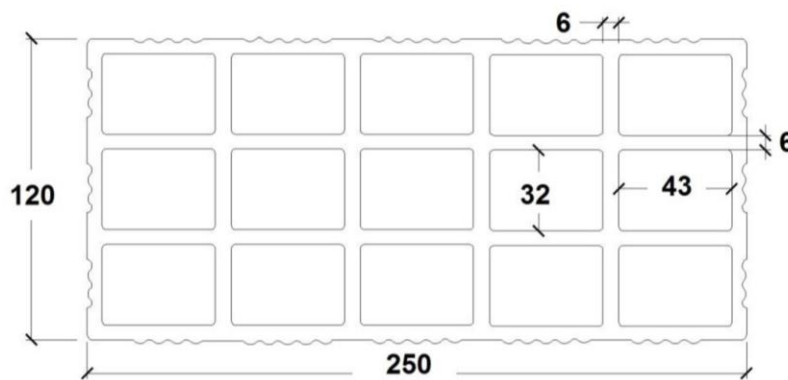
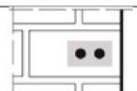
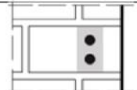

Table C89: Installation parameters

Anchor size		[-]	All sizes
Edge distance	C_{cr}	[mm]	100 (120) ¹⁾
Minimum edge distance	C_{min}	[mm]	60
Spacing	$S_{cr,II}$	[mm]	250
	$S_{cr,L}$	[mm]	120
Minimum spacing	S_{min}	[mm]	100

¹⁾ Value in brackets for SH20x85; SH20x130 and SH20x200

Table C90: Group factor for anchor group in case of tension loading

Configuration		with $c \geq$	with $s \geq$	$\alpha_{g,N,II}$	[-]	
II: anchors placed parallel to horizontal joint		60	100			
		C_{cr}	250			
I: anchors placed perpendicular to horizontal joint		60	100	$\alpha_{g,N,I}$	2,0	

ESSVE Injection system ONE, ONE ICE for masonry

Performances clay hollow brick Blocchi Leggeri

Description of the brick
Installation parameters

Annex C 36

Brick type: Clay hollow brick Blocchi Leggeri

Table C91: Group factor for anchor group in case of shear loading parallel to free edge

Configuration		with $c \geq$	with $s \geq$			
II: anchors placed parallel to horizontal joint		$60^{1)}$	$100^{1)}$	$\alpha_{g,V,II}$	[-]	1,0
		c_{cr}	250			2,0
⊥: anchors placed perpendicular to horizontal joint		$60^{1)}$	$100^{1)}$	$\alpha_{g,V,\perp}$		1,6
		c_{cr}	250			2,0

¹⁾ Only valid for $V_{Rk,b}$ according to Table C93 and C94 values in brackets

Table C92: Group factor for anchor group in case of shear loading perpendicular to free edge

Configuration		with $c \geq$	with $s \geq$			
II: anchors placed parallel to horizontal joint		$60^{1)}$	$100^{1)}$	$\alpha_{g,V,II}$	[-]	1,0
		c_{cr}	250			2,0
⊥: anchors placed perpendicular to horizontal joint		$60^{1)}$	$100^{1)}$	$\alpha_{g,V,\perp}$		1,6
		c_{cr}	250			2,0

¹⁾ Only valid for $V_{Rk,b}$ according to Table C93 and C94 values in brackets

Table C93: Characteristic values of resistance under tension and shear loads

Anchor size	Sleeve	Effective anchorage depth	Characteristic resistance			
			Use category			
			d/d; w/d; w/w			
			40°C/24°C	80°C/50°C	120°C/72°C	For all temperature range
		h_{ef}	$N_{Rk,b} = N_{Rk,p}^{1)}$			$V_{Rk,b}^{4)}$
		[mm]	[kN]			
Compressive strength $f_b \geq 4 \text{ N/mm}^2$						
M8	12x80	80	0,4	0,4	0,3	$2,0^{2)}$ ($0,9^{3)}$
M8 / M10 / IG-M6	16x85	85				
	16x130	130				
M12 / M16 / IG-M8 / IG-M10	20x85	85				
	20x130	130				
	20x200	200				
Compressive strength $f_b \geq 6 \text{ N/mm}^2$						
M8	12x80	80	0,5	0,5	0,4	$2,5^{2)}$ ($1,2^{3)}$
M8 / M10 / IG-M6	16x85	85				
	16x130	130				
M12 / M16 / IG-M8 / IG-M10	20x85	85				
	20x130	130				
	20x200	200				

¹⁾ Values are valid for c_{cr} and c_{min}

²⁾ Calculation of $V_{Rk,c}$ see Technical Report TR 054, except for shear load parallel to free edge with $c \geq 125 \text{ mm}$: $V_{Rk,c,II} = V_{Rk,b}$

³⁾ Values in brackets $V_{Rk,c} = V_{Rk,b}$ for anchors with c_{min}

⁴⁾ The values are valid for steel 5.6 or greater. For steel 4.6 and 4.8 multiply $V_{Rk,b}$ by 0,8

ESSVE Injection system ONE, ONE ICE for masonry

Performances clay hollow brick Blocchi Leggeri

Installation parameters (continue)

Characteristic values of resistance under tension and shear load

Annex C 37

Brick type: Clay hollow brick Blocchi Leggeri

Table C94: Characteristic values of resistance under tension and shear loads (continue)

Anchor size	Sleeve	Effective anchorage depth	Characteristic resistance			
			Use category			
			d/d w/d w/w			
			40°C/24°C	80°C/50°C	120°C/72°C	For all temperature range
h_{ef}	$N_{Rk,b} = N_{Rk,d}^{1)}$			$V_{Rk,b}^{4)}$		
[mm]	[kN]					

Compressive strength $f_b \geq 8 \text{ N/mm}^2$

Anchor size	Sleeve	Effective anchorage depth	40°C/24°C	80°C/50°C	120°C/72°C	For all temperature range
M8	12x80	80	0,6	0,6	0,5	3,0 ²⁾ (1,2) ³⁾
M8 / M10 / IG-M6	16x85	85				
	16x130	130				
M12 / M16 / IG-M8 / IG-M10	20x85	85				
	20x130	130				
	20x200	200				

Compressive strength $f_b \geq 12 \text{ N/mm}^2$

Anchor size	Sleeve	Effective anchorage depth	40°C/24°C	80°C/50°C	120°C/72°C	For all temperature range
M8	12x80	80	0,6	0,6	0,6	3,5 ²⁾ (1,5) ³⁾
M8 / M10 / IG-M6	16x85	85				
	16x130	130				
M12 / M16 / IG-M8 / IG-M10	20x85	85				
	20x130	130				
	20x200	200				

- 1) Values are valid for c_{cr} and c_{min}
- 2) Calculation of $V_{Rk,c}$ see Technical Report TR 054, except for shear load parallel to free edge with $c \geq 125 \text{ mm}$: $V_{Rk,c,II} = V_{Rk,b}$
- 3) Values in brackets $V_{Rk,c} = V_{Rk,b}$ for anchors with c_{min}
- 4) The values are valid for steel 5.6 or greater. For steel 4.6 and 4.8 multiply $V_{Rk,b}$ by 0,8

Table C95: Displacements

Anchor size	Sleeve	Effective anchorage depth h_{ef}	N	δ_N / N	δ_{N0}	$\delta_{N\infty}$	V	δ_{V0}	$\delta_{V\infty}$
			[kN]	[mm/kN]	[mm]	[mm]	[kN]	[mm]	[mm]
All sizes	All sizes	All sizes	0,17	1,20	0,21	0,41	0,9	1,20	1,80

ESSVE Injection system ONE, ONE ICE for masonry

Performances clay hollow brick Blocchi Leggeri

Characteristic values of resistance under tension and shear load (continue)
Displacements

Annex C 38

Brick type: Clay hollow brick Doppio Uni

Table C96: Description of the brick

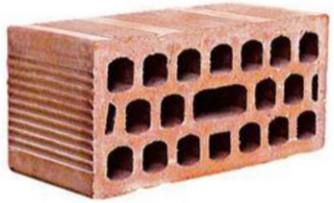
Brick type	Clay hollow brick Doppio Uni	
Bulk density ρ [kg/dm ³]	0,9	
Compressive strength $f_b \geq$ [N/mm ²]	10, 16, 20 or 28	
Code	EN 771-1	
Producer (country code)	e.g. Wienerberger (IT)	
Brick dimensions [mm]	250 x 120 x 120	
Drilling method	Rotary	

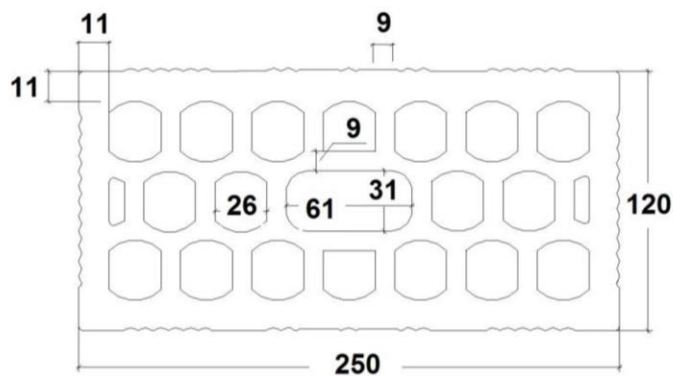

Table C97: Installation parameters

Anchor size		[-]	All sizes
Edge distance	C_{cr}	[mm]	100 (120) ¹⁾
Minimum edge distance	C_{min} ²⁾	[mm]	60
Spacing	$S_{cr,II}$	[mm]	250
	$S_{cr,\perp}$	[mm]	120
Minimum spacing	$S_{min,II}$	[mm]	100
	$S_{min,\perp}$	[mm]	120

¹⁾ Value in brackets for SH20x85; SH20x130 and SH20x200

²⁾ For $V_{Rk,c}$: C_{min} according to Technical Report TR 054

Table C98: Group factor for anchor group in case of tension loading

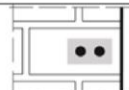
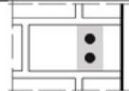
Configuration		with $c \geq$	with $s \geq$			
II: anchors placed parallel to horizontal joint		60	100	$\alpha_{g,N,II}$	[-]	1,0
		C_{cr}	250			2,0
\perp : anchors placed perpendicular to horizontal joint		60	120	$\alpha_{g,N,\perp}$		2,0

ESSVE Injection system ONE, ONE ICE for masonry

Performances clay hollow brick Doppio Uni

Description of the brick
Installation parameters

Annex C 39

Brick type: Clay hollow brick Doppio Uni

Table C99: Group factor for anchor group in case of shear loading parallel to free edge

Configuration		with $c \geq$	with $s \geq$			
II: anchors placed parallel to horizontal joint		C_{Cr}	250	$\alpha_{g,V,II}$	[-]	2,0
⊥: anchors placed perpendicular to horizontal joint		C_{Cr}	120	$\alpha_{g,V,\perp}$		2,0

Table C100: Group factor for anchor group in case of shear loading perpendicular to free edge

Configuration		with $c \geq$	with $s \geq$			
II: anchors placed parallel to horizontal joint		C_{Cr}	250	$\alpha_{g,V,II}$	[-]	2,0
⊥: anchors placed perpendicular to horizontal joint		C_{Cr}	120	$\alpha_{g,V,\perp}$		2,0

Table C101: Characteristic values of resistance under tension and shear loads

Anchor size	Sleeve	Effective anchorage depth	Characteristic resistance			
			Use category			
			d/d w/d w/w			
			40°C/24°C	80°C/50°C	120°C/72°C	For All temperature range
		h_{ef}	$N_{Rk,b} = N_{Rk,p}^{1)}$			$V_{Rk,b}^{2)3)}$
		[mm]	[kN]			
Compressive strength $f_b \geq 10 \text{ N/mm}^2$						
M8	12x80	80	0,6	0,6	0,5	1,5
M8 / M10 / IG-M6	16x85	85				
	16x130	130				
M12 / M16 / IG-M8 / IG-M10	20x85	85				
	20x130	130				
	20x200	200				
Compressive strength $f_b \geq 16 \text{ N/mm}^2$						
M8	12x80	80	0,75	0,75	0,6	2,0
M8 / M10 / IG-M6	16x85	85				
	16x130	130				
M12 / M16 / IG-M8 / IG-M10	20x85	85				
	20x130	130				
	20x200	200				

1) Values are valid for c_{Cr} and c_{min}

2) Calculation of $V_{Rk,c}$ see Technical Report TR 054

3) The values are valid for steel 5.6 or greater. For steel 4.6 and 4.8 multiply $V_{Rk,b}$ by 0,8

ESSVE Injection system ONE, ONE ICE for masonry

Performances clay hollow brick Doppio Uni

Installation parameters (continue)

Characteristic values of resistance under tension and shear load

Annex C 40

Brick type: Clay hollow brick Doppio Uni

Table C102: Characteristic values of resistance under tension and shear loads (continue)

Anchor size	Sleeve	Effective anchorage depth	Characteristic resistance			
			Use category			
			d/d w/d w/w			
			40°C/24°C	80°C/50°C	120°C/72°C	For All temperature range
h_{ef}	$N_{Rk,b} = N_{Rk,d}^{1)}$			$V_{Rk,b}^{2)3)}$		
[mm]	[kN]					
Compressive strength $f_b \geq 20 \text{ N/mm}^2$						
M8	12x80	80	0,9	0,9	0,75	2,0
M8 / M10/ IG-M6	16x85	85				
	16x130	130				
M12 / M16 / IG-M8 / IG-M10	20x85	85				
	20x130	130				
	20x200	200				
Compressive strength $f_b \geq 28 \text{ N/mm}^2$						
M8	12x80	80	1,2	1,2	0,9	2,5
M8 / M10/ IG-M6	16x85	85				
	16x130	130				
M12 / M16 / IG-M8 / IG-M10	20x85	85				
	20x130	130				
	20x200	200				

1) Values are valid for c_{cr} and c_{min}

2) Calculation of $V_{Rk,c}$ see Technical Report TR 054

3) The values are valid for steel 5.6 or greater. For steel 4.6 and 4.8 multiply $V_{Rk,b}$ by 0,8

Table C103: Displacements

Anchor size	Sleeve	Effective anchorage depth h_{ef}	N	δ_N / N	δ_{N0}	$\delta_{N\infty}$	V	δ_{V0}	$\delta_{V\infty}$
		[mm]	[kN]	[mm/kN]	[mm]	[mm]	[kN]	[mm]	[mm]
All sizes	All sizes	All sizes	0,26	1,20	0,31	0,62	0,6	0,3	0,45

ESSVE Injection system ONE, ONE ICE for masonry

Performances clay hollow brick Doppio Uni

Characteristic values of resistance under tension and shear load (continue)

Displacements

Annex C 41

Brick type: Hollow Light weight concrete Bloc creux B40

Table C104: Description of the brick

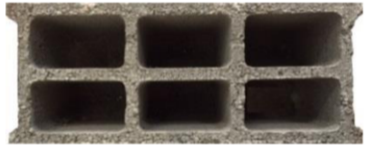
Brick type	Hollow light weight concrete Bloc creux B40	
Bulk density ρ [kg/dm ³]	0,8	
Compressive strength $f_b \geq$ [N/mm ²]	4	
Code	EN 771-3	
Producer (country code)	e.g. Sepa (FR)	
Brick dimensions [mm]	494 x 200 x 190	
Drilling method	Rotary	

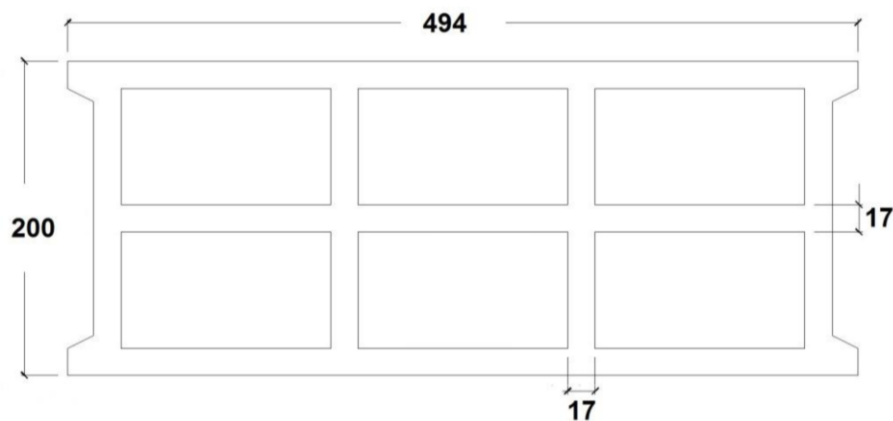

Table C105: Installation parameters

Anchor size		[-]	All sizes
Edge distance	C_{cr}	[mm]	100 (120) ¹⁾
Minimum edge distance	C_{min} ²⁾	[mm]	100 (120) ¹⁾
Spacing	$S_{cr, }$	[mm]	494
	$S_{cr,\perp}$	[mm]	190
Minimum spacing	S_{min}	[mm]	100

¹⁾ Value in brackets for SH20x85 and SH20x130

²⁾ For $V_{Rk,c}$: C_{min} according to Technical Report TR 054

Table C106: Group factor for anchor group in case of tension loading

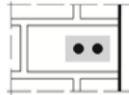
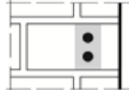
Configuration		with $c \geq$	with $s \geq$	$\alpha_{g,N, }$	[-]	
: anchors placed parallel to horizontal joint		100	100			
		C_{cr}	494	2,0		
⊥: anchors placed perpendicular to horizontal joint		100	100	$\alpha_{g,N,\perp}$		1,0
		C_{cr}	190			2,0

ESSVE Injection system ONE, ONE ICE for masonry

Performances hollow light weight concrete Bloc creux B40

Description of the brick
Installation parameters

Annex C 42

Brick type: Hollow Light weight concrete Bloc creux B40

Table C107: Group factor for anchor group in case of shear loading parallel to free edge

Configuration		with $c \geq$	with $s \geq$			
II: anchors placed parallel to horizontal joint		50	100	$\alpha_{g,V,II}$	[-]	1,1
		c_{cr}	494			2,0
⊥: anchors placed perpendicular to horizontal joint		100	100	$\alpha_{g,V,\perp}$	[-]	1,1
		c_{cr}	190			2,0

Table C108: Group factor for anchor group in case of shear loading perpendicular to free edge

Configuration		with $c \geq$	with $s \geq$			
II: anchors placed parallel to horizontal joint		c_{cr}	494	$\alpha_{g,V,II}$	[-]	2,0
		c_{cr}	190			$\alpha_{g,V,\perp}$

Table C109: Characteristic values of resistance under tension and shear loads

Anchor size	Sleeve	Effective anchorage depth	Characteristic resistance						
			Use category						
			d/d			w/d			d/d
			40°C/24°C	80°C/50°C	120°C/72°C	40°C/24°C	80°C/50°C	120°C/72°C	w/d
		h_{ef}	$N_{Rk,b} = N_{Rk,p}^{1)}$			$N_{Rk,b} = N_{Rk,p}^{1)}$			For all temperature range
		[mm]	[kN]						
Compressive strength $f_b \geq 4 \text{ N/mm}^2$									
M8	12x80	80	1,2	0,9	0,75	0,9	0,9	0,75	3,0
M8 / M10 / IG-M6	16x85	85	1,2	0,9	0,75	1,2	0,9	0,75	3,0
	16x130	130	1,2	0,9	0,75	1,2	0,9	0,75	3,0
M12 / M16 / IG-M8 / IG-M10	20x85	85	1,2	0,9	0,75	1,2	0,9	0,75	3,0
	20x130	130	1,2	0,9	0,75	1,2	0,9	0,75	3,0

¹⁾ Values are valid for c_{cr} and c_{min}

²⁾ Calculation of $V_{Rk,c}$ see Technical Report TR 054, except for shear load parallel to free edge with $c \geq 250 \text{ mm}$: $V_{Rk,c,II} = V_{Rk,b}$

³⁾ The values are valid for steel 5.6 or greater. For steel 4.6 and 4.8 multiply $V_{Rk,b}$ by 0,8

Table C110: Displacements

Anchor size	Sleeve	Effective anchorage depth h_{ef}	N	δ_N / N	δ_{N0}	$\delta_{N\infty}$	V	δ_{V0}	$\delta_{V\infty}$
			[kN]	[mm/kN]	[mm]	[mm]	[kN]	[mm]	[mm]
All sizes	All sizes	All sizes	0,34	0,90	0,31	0,62	0,86	0,9	1,35

ESSVE Injection system ONE, ONE ICE for masonry

Performances hollow light weight concrete brick Bloc creux B40

Installation parameters (continue)

Characteristic values of resistance under tension and shear load / Displacements

Annex C 43

Brick type: Solid light weight concrete brick - LAC

Table C111: Description of the brick

Brick type	Solid light weight concrete brick		
Bulk density ρ [kg/dm ³]	0,6		
Compressive strength $f_b \geq$ [N/mm ²]	2		
Code	EN 771-3		
Producer (country code)	e.g. Bisotherm (DE)		
Brick dimensions [mm]	300 x 123 x 248		
Drilling method	Rotary		

Table C112: Installation parameter

Anchor size		[-]	All sizes
Edge distance	c_{cr}	[mm]	$1,5 \cdot h_{ef}$
Minimum edge distance	c_{min}	[mm]	60
Spacing	s_{cr}	[mm]	$3 \cdot h_{ef}$
Minimum spacing	s_{min}	[mm]	120

Table C113: Group factor for anchor group in case of tension loading

Configuration		with $c \geq$	with $s \geq$			
II: anchors placed parallel to horizontal joint		90	120	$\alpha_{g,N,II}$	[-]	1,1
		$1,5 \cdot h_{ef}$	$3 \cdot h_{ef}$			2,0
⊥: anchors placed perpendicular to horizontal joint		124	120	$\alpha_{g,N,\perp}$		1,1
		$1,5 \cdot h_{ef}$	$3 \cdot h_{ef}$			2,0

Table C114: Group factor for anchor group in case of shear loading parallel to free edge

Configuration		with $c \geq$	with $s \geq$			
II: anchors placed parallel to horizontal joint		60	120	$\alpha_{g,V,II}$	[-]	0,6
		90	120			2,0
⊥: anchors placed perpendicular to horizontal joint		60	120	$\alpha_{g,V,\perp}$		0,6
		124	120			2,0

Table C115: Group factor for anchor group in case of shear loading perpendicular to free edge

Configuration		with $c \geq$	with $s \geq$			
II: anchors placed parallel to horizontal joint		60	120	$\alpha_{g,V,II}$	[-]	0,6
		90	120			2,0
⊥: anchors placed perpendicular to horizontal joint		60	120	$\alpha_{g,V,\perp}$		0,6
		$1,5 \cdot h_{ef}$	120			1,0
		$1,5 \cdot h_{ef}$	$3 \cdot h_{ef}$		2,0	

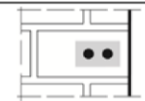
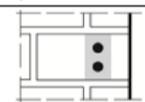
ESSVE Injection system ONE, ONE ICE for masonry

Performances solid light weight concrete brick - LAC

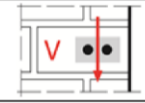
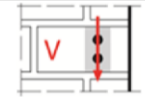
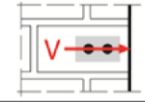
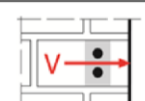
Description of the brick
Installation parameters

Annex C 44

Brick type: Solid light weight concrete brick - LAC

Table C116: Characteristic values of resistance under tension and shear loads

Anchor size	Sleeve	Effective anchorage depth	Characteristic resistance						
			Use category						
			d/d			w/d w/w			d/d w/d w/w
			40°C/24°C	80°C/50°C	120°C/72°C	40°C/24°C	80°C/50°C	120°C/72°C	For all temperature range
h_{ef}	$N_{Rk,b} = N_{Rk,p}^{1)}$			$N_{Rk,b} = N_{Rk,p}^{1)}$			$V_{Rk,b}^{2)3)}$		
[mm]	[kN]								
Compressive strength $f_b \geq 2 \text{ N/mm}^2$									
M8	-	80	3,0	2,5	2,0	2,5	2,0	1,5	3,0
M8 / M10/ IG-M6	-	90	3,0	3,0	2,0	2,5	2,5	2,0	3,0
M10 / IG-M8	-	100	3,5	3,0	2,5	3,0	2,5	2,0	3,0
M16 / IG-M10	-	100	3,0	3,0	2,0	3,0	3,0	2,0	3,0
M8	12x80	80	2,5	2,5	2,0	2,5	2,0	1,5	3,0
M8 / M10/ IG-M6	16x85	85	3,0	2,5	2,0	3,0	2,5	2,0	3,0
	16x130	130	3,0	2,5	2,0	3,0	2,5	2,0	3,0
M12 / M16 / IG-M8 / IG-M10	20x85	85	2,5	2,5	2,0	2,5	2,5	2,0	3,0
	20x130	130	2,5	2,5	2,0	2,5	2,5	2,0	3,0
	20x200	200	2,5	2,5	2,0	2,5	2,5	2,0	3,0

¹⁾ Values are valid for c_{Cr} , values in brackets are valid for single anchors with c_{min}

²⁾ For calculation of $V_{Rk,c}$ see ETAG029, Annex C

³⁾ The values are valid for steel 5.6 or greater. For steel 4.6 and 4.8 multiply $V_{Rk,b}$ by 0,8

Table C117: Displacements

Anchor size	Sleeve	Effective anchorage depth h_{ef}	N	δ_N / N	δ_{N0}	$\delta_{N\infty}$	V	δ_{V0}	$\delta_{V\infty}$
			[kN]	[mm/kN]	[mm]	[mm]	[kN]	[mm]	[mm]
M8	-	80	0,86	0,50	0,43	0,86	0,9	0,25	0,38
M8 / M10/ IG-M6	-	90							
M10 / IG-M8	-	100							
M16 / IG-M10	-	100	0,71	0,35	0,25	0,50			
M8	12x80	80							
M8 / M10/ IG-M6	16x85	85							
	16x130	130							
M12 / M16 / IG-M8 / IG-M10	20x85	85	0,71	0,35	0,25	0,50			
	20x130	130							
	20x200	200							

ESSVE Injection system ONE, ONE ICE for masonry

Performances solid light weight concrete brick - LAC
Characteristic values of resistance under tension and shear load
Displacements

Annex C 45